



TARIFA 2018



INDICE VALME

PAG

Abrazaderas de Reparacion INOX	8
Bridas Antitraccion	10
Bocas de Riego	16
Bridas de Acero	11-12
Bridas de Doble Camara para PVC/PE	8
Bridas Reductoras	7
Bridas Universales	9
Carretes de Desmontaje	7
Collarin de Fundicion para PVC (2 Torn.)	14
Collarin de Fundicion para PVC/PE (4 Torn.)	15
Filtros en "Y" C/Bridas	6
Grifos de Esfera de Laton	19
Laton Desmontable con bridas para PE	18
Latón Desmontable rosca Exterior para PE	17
Manguitos Elasticos (Bridas y Roscado)	5
Uniones Antitraccion	10
Uniones Gibault para PVC	13
Uniones Universales	9
Valvulas de Compuerta de Fundicion	3
Valvulas de Esfera de Laton	19
Válvulas de Mariposa de Fundicion	4
Valvulas de Retención de Fundicion	5-6
Ventosas	6

VALVULAS DE FUNDICION

COMPUERTA ELASTICA C/BRIDAS PN16

DN	CODIGO	P.V.P.
50	120100050	81,49
65	120100065	99,81
80	120100080	125,53
100	120100100	158,81
125	120100125	212,69
150	120100150	256,38
200	120100200	383,00
250	120100250	625,13
300	120100300	868,19
350	120100350	1966,95
400	120100400	2471,03
500	120100500	4651,37
200 (PN10)	120109200	383,00



VOLANTE VALVULA DE COMPUERTA

DN	CODIGO	P.V.P.
50-100	120000050	8,55
125-150	120000125	16,40
200-300	120000200	24,33
350	120000350	68,40
400	120000400	68,40
450-600	120000450	98,80



CUADRADILLO VALVULA DE COMPUERTA

DN	CODIGO	P.V.P.
50-100	120000510	8,55
125-150	120001215	8,55
200-300	120002030	12,83
350	120003500	24,37
400	120004000	24,37
450-600	120004560	40,43



COMPUERTA ELASTICA ROSCADA

ROSCA	CODIGO	P.V.P.
3/4"	120700025	65,10
1"	120700032	65,10
1 1/4"	120700040	71,40
1 1/2"	120700050	85,84
2"	120700063	95,67





VALVULAS DE FUNDICION

MARIPOSA DISCO DUCTIL C/PALANCA

DN	CODIGO	P.V.P.
50	130100050	32,83
65	130100065	37,54
80	130100080	41,30
100	130100100	51,65
125	130100125	71,76
150	130100150	80,27
200	130100200	141,30



MARIPOSA DISCO INOX C/PALANCA

DN	CODIGO	P.V.P.
50	130200050	40,76
65	130200065	53,45
80	130200080	58,36
100	130200100	75,17
125	130200125	118,99
150	130200150	130,48
200	130200200	214,96

MARIPOSA DISCO DUCTIL C/REDUCTOR

DN	CODIGO	P.V.P.
50	130110050	68,43
65	130110065	73,43
80	130110080	82,98
100	130110100	94,43
125	130110125	105,88
150	130110150	124,48
200	130110200	191,04
250	130110250	261,12
300	130110300	344,25
350	130110350	534,19
400	130110400	945,00
450	130110450	1164,29
500	130110500	1509,75



MARIPOSA DISCO INOX C/REDUCTOR

DN	CODIGO	P.V.P.
80	130210080	88,31
100	130210100	104,25
125	130210125	137,55
150	130210150	170,06
200	130210200	272,60
250	130210250	416,50
300	130210300	627,91
350	130210350	949,05
400	130210400	1512,50
500	130210500	2336,25



VALVULAS DE FUNDICION

RETENCION DE BOLA C/BRIDAS PN16			RETENCION DE BOLA ROSCADA		
DN	CODIGO	P.V.P.	ROSCA	CODIGO	P.V.P.
50	160100050	88,93	1"	160150032	42,70
65	160100065	114,28	1 1/4"	160150040	46,60
80	160100080	145,53	1 1/2"	160150050	57,51
100	160100100	192,88	2"	160150063	92,21
125	160100125	291,63	2 1/2"	160150075	136,64
150	160100150	388,05	3"	160150090	182,68
200	160100200	728,45			
200 (PN10)	160109200	728,45			
250 (PN10)	160109250	1340,98			
300 (PN10)	160109300	1865,38			



MANGUITO ELASTICO C/BRIDAS PN16			MANGUITO ELASTICO ROSCADO		
DN	CODIGO	P.V.P.	ROSCA	CODIGO	P.V.P.
50	210200050	31,50	3/4"	210300025	19,55
65	210200065	40,95	1"	210300032	24,29
80	210200080	46,56	1 1/4"	210300040	28,26
100	210200100	58,20	1 1/2"	210300050	36,20
125	210200125	87,30	2"	210300063	46,89
150	210200150	104,76	2 1/2"	210300075	74,49
200	210200200	174,60	3"	210300090	87,43
250	210200250	281,30			
300	210200300	340,47			
200 (PN10)	210209200	174,60			
250 (PN10)	210209250	256,08			
300 (PN10)	210209300	309,43			





VALVULAS DE FUNDICION

RUBER-CHECK DISCO INOX

DN	CODIGO	P.V.P.
50	160210050	30,80
65	160210065	35,33
80	160210080	47,46
100	160210100	59,05
125	160210125	80,24
150	160210150	117,10
200	160210200	195,82
250	160210250	285,18
300	160210300	443,80
350	160210350	812,25
400	160210400	1258,75
450	160210450	1721,25
500	160210500	2217,50



CLAPETA C/BRIDAS PN16

DN	CODIGO	P.V.P.
60	160400060	177,39
70	160400070	210,24
80	160400080	238,71
100	160400100	286,89
125	160400125	420,48
150	160400150	584,73
200	160400200	952,65
250	160400250	1403,79
300	160400300	2111,16
350	160400350	2457,18
400	160400400	3992,37



FILTROS C/BRIDAS MALLA INOX PN16

DN	CODIGO	P.V.P.
32	150100032	39,71
40	150100040	46,69
50	150100050	63,03
65	150100065	90,28
80	150100080	102,98
100	150100100	135,10
125	150100125	196,85
150	150100150	273,80
200	150100200	483,98
250	150100250	828,03
300	150100300	1224,23



VENTOSA TRIPLE EFECTO C/BRIDAS

DN	CODIGO	P.V.P.
50	190120050	292,60
65	190120065	334,40
80	190120080	437,00
100	190120100	570,00



*Disponemos de filtros en "L" y "T"



CARRETES DE DESMONTAJE

BRIDAS PN10 VIOLAS INOX			BRIDAS PN16 VIOLAS INOX		
DN	CODIGO	P.V.P.	DN	CODIGO	P.V.P.
			50	270100050	210,00
			65	270100065	218,75
			80	270110080	227,50
			100	270100100	236,25
			125	270100125	252,00
			150	270100150	262,50
200	270100200	336,00	200	270110200	336,00
250	270100250	420,00	250	270110250	420,00
300	270100300	525,00	300	270110300	525,00
350	270100350	630,00	350	270110350	630,00
400	270100400	875,00	400	270110400	875,00
450	270100450	1050,00	450	270110450	1050,00
500	270100500	1260,00	500	270110500	1260,00
600	270100600	1575,00	600	270110600	1575,00



BRIDAS REDUCTORAS

BRIDAS REDUCTORAS					
DN	CODIGO	P.V.P.	DN	CODIGO	P.V.P.
65-50	750110605	46,15	200-80	750112008	112,46
80-50	750110805	47,16	200-100	750112010	117,29
80-65	750110806	49,14	200-150	750112015	116,21
100-50	750111005	53,10	250-80	750112508	176,62
100-65	750111006	55,55	250-100	750112510	179,64
100-80	750111008	70,78	250-125	750112512	184,28
125-65	750111206	59,98	250-150	750112515	189,61
125-80	750111208	75,67	250-200	750112520	216,12
125-100	750111210	74,70	300-100	750113010	189,65
150-65	750111506	69,80	300-125	750113012	199,58
150-80	750111508	87,48	300-150	750113015	202,90
150-100	750111510	88,45	300-200	750113020	212,87
150-125	750111512	84,53	300-250	750113025	200,56





BRIDAS DOBLE CAMARA

PARA PVC			PARA PE		
DN	CODIGO	P.V.P.	DN	CODIGO	P.V.P.
65x63	410100063	23,63	50x63	410200063	29,61
65x75	410100075	25,33	65x75	410200075	30,25
80x90	410100090	28,49	80x90	410200090	36,04
100x110	410100110	37,24	100x110	410200110	42,46
125x125	410100125	42,34	125x125	410200125	54,07
125x140	410100140	45,61	125x140	410200140	56,63
150x160	410100160	56,95	150x160	410200160	72,09
200x200	410100200	103,48	200x200	410200200	108,95
250x250	410100250	135,42	250x250	410200250	161,79
300x315	410100315	193,07	300x315	410200315	210,54



ABRAZADERA DE REPARACIÓN INOX

1 CIERRE (200MM)			2 CIERRES (200MM)		
DN	CODIGO	P.V.P.	DN	CODIGO	P.V.P.
48-52	8212048052	67,66	140-160	822140160	240,80
60-67	8212060067	70,65	159-180	822159180	245,00
70-77	8212070077	77,61	176-196	822176196	254,80
75-83	8212075083	77,61	190-210	822190210	264,60
82-89	8212082089	78,61	210-230	822210230	274,40
87-94	8212087094	79,60	225-246	822225246	302,40
94-102	8212094102	82,59	240-260	822240260	310,80
102-112	8212102112	84,58	250-270	822250270	313,60
108-118	8212108118	85,57	269-289	822269289	317,80
118-128	8212118128	87,56	282-302	822282302	322,00
120-131	8212120131	88,56	299-330	822299330	327,60
125-135	8212125135	88,56	315-335	822315335	327,60
135-145	8212135145	94,53	322-344	822322344	331,80
145-155	8212145155	95,52	337-358	822337358	334,60
151-161	8212151161	99,50	347-367	822347367	338,80
			365-385	822365385	343,00
			382-402	822382402	361,20
			396-420	822396420	364,00
			410-430	822410430	366,80
			420-440	822420440	368,20
			435-455	822435455	371,00



BRIDAS Y UNIONES UNIVERSALES

BRIDA UNIVERSAL			
DN	RANGO	CODIGO	P.V.P.
40-50	58-74	200600058	36,90
50-65	68-84	200600068	43,20
65-80	84-105	200600084	50,40
100	99-118	200600099	54,00
100	109-133	200600109	67,50
125-150	133-157	200600133	77,40
150	157-182	200600157	85,50
150	177-201	200600177	103,50
200	194-215	200600194	104,40
200	218-242	200600218	128,70
250	242-268	200600242	153,00
250	266-291	200600266	163,80
250	280-305	200600280	190,80
300	302-327	200600302	200,70
300	324-350	200600324	223,67
350	352-378	200600352	307,40
350	374-391	200600374	307,40
400	384-410	200600386	387,00
450	480-500	200600480	398,78
500	526-546	200600526	566,76



UNION UNIVERSAL			
	RANGO	CODIGO	P.V.P.
	58-74	280600058	33,30
	68-84	280600068	41,40
	84-105	280600084	53,10
	99-118	280600099	56,70
	109-133	280600109	64,80
	133-157	280600133	88,20
	157-182	280600157	90,00
	177-201	280600177	100,80
	194-215	280600194	110,70
	218-242	280600218	127,80
	242-268	280600242	161,10
	266-291	280600266	180,00
	280-305	280600280	189,00
	302-327	280600302	191,70
	324-350	280600324	239,40
	352-378	280600352	307,80
	374-391	280600374	311,40
	384-410	280600386	318,60
	417-437	280600417	322,53
	498-516	280600498	390,92
	526-546	280600526	517,48
	630-650	280600630	545,93





BRIDAS Y UNIONES ANTITRACCION PARA TUBO PVC/PE

BRIDA ANTITRACCION			
TUBO	DN	CODIGO	P.V.P.
63	50	200700063	61,74
75	65	200700075	67,62
90	80	200700090	74,48
110	100	200700110	88,20
125	125	200700125	124,46
140	125	200700140	126,42
160	150	200700160	143,08
200	200	200700200	202,86
250	250	200700250	394,94
315	300	200700315	480,20
355	300	200700354	597,06
355	350	200700355	694,26
400	400	200700400	791,42
450	400	200700449	999,72
450	450	200700450	1062,18
500	500	200700500	1180,22
560	500	200700560	1291,28
630	600	200700630	1527,35



UNION ANTITRACCION			
	DN	CODIGO	P.V.P.
	63	280700063	63,70
	75	280700075	71,54
	90	280700090	82,32
	110	280700110	105,84
	125	280700125	143,08
	140	280700140	157,78
	160	280700160	173,46
	200	280700200	240,10
	250	280700250	488,04
	315	280700315	686,00
	355	280700355	855,54
	400	280700400	919,24
	450	280700450	984,28
	500	280700500	1069,11
	560	280700560	1166,34
	630	280700630	1249,65





BRIDAS DE ACERO

PARA PVC PN16			PARA PE PN16		
DN	CODIGO	P.V.P.	DN	CODIGO	P.V.P.
50/50	200100050	6,98	40/50	200150050	7,74
50/63	200100063	6,98	50/63	200150063	9,97
65/75	200100075	8,53	65/75	200150075	12,35
80/90	200100090	8,86	80/90	200150090	15,23
100/110	200100110	9,86	100/110	200150110	16,60
125/125	200100125	13,21	125/125	200150125	25,67
125/140	200100140	13,21	125/140	200150140	21,56
150/160	200100160	14,44	150/160	200150160	28,12
200/200	200100200	23,69	150/180	200150160	25,84
250/250	200100250	31,64	200/200	200150200	35,64
300/315	200100315	35,78	250/250	200150250	55,12
200/200 ⁽¹⁰⁾	200109200	24,52	250/280	200150280	51,96
250/250 ⁽¹⁰⁾	200109250	29,23	300/315	200150315	70,13
300/315 ⁽¹⁰⁾	200109315	31,00	400/400	200150400	132,44
			500/500	200150500	207,39
			600/630	200150630	334,24
			200/200 ⁽¹⁰⁾	200159200	36,97
			250/250 ⁽¹⁰⁾	200159250	48,99
			300/315 ⁽¹⁰⁾	200159315	62,37
			400/400 ⁽¹⁰⁾	200159400	118,19
			500/500 ⁽¹⁰⁾	200159500	190,87
			600/630 ⁽¹⁰⁾	200159630	252,63



ROSCADAS			
DN	ROSCA	CODIGO	P.V.P.
15	1/2"	200400015	6,44
20	3/4"	200400020	7,25
25	1"	200400025	8,51
32	1 1/4"	200400032	9,32
40	1 1/2"	200400040	10,28
50	2"	200400050	13,16
65	2 1/2"	200400065	16,12
80	3"	200400080	20,42
100	4"	200400100	21,67
25	1 1/4"	200400024	11,65
25	1 1/2"	200400026	11,65
32	1"	200400034	13,59
32	1 1/2"	200400036	13,90
40	1"	200400044	14,78
40	1 1/4"	200400045	15,09
40	2"	200400047	15,40
50	1"	200400054	17,98
50	1 1/4"	200400055	18,29
50	1 1/2"	200400056	18,29
50	2 1/2"	200400058	21,10
65	1 1/2"	200400066	21,49
65	2"	200400067	21,80
80	1 1/2"	200400086	26,11
80	2"	200400087	24,31
80	2 1/2"	200400088	26,61

ROSCADAS			
DN	ROSCA	CODIGO	P.V.P.
100	1 1/2"	200400106	29,55
100	2"	200400107	27,48
100	2 1/2"	200400108	29,77
100	3"	200400109	30,06
125	2"	200400127	41,13
125	2 1/2"	200400128	43,62
125	3"	200400129	43,94
150	1 1/2"	200400156	48,76
150	2"	200400157	49,07
150	2 1/2"	200400158	51,57
150	3"	200400159	51,88
200	2"	200400207	74,80
200	2 1/2"	200400208	77,29
200	3"	200400209	77,61
250	2"	200400257	119,06
250	3"	200400259	122,14
300	2"	200400307	164,83
300	3"	200400309	167,92



BRIDAS DE ACERO

SOLDAR PN10 (DIN 2576)			SOLDAR PN16 (DIN 2502)		
DN	CODIGO	P.V.P.	DN	CODIGO	P.V.P.
15	200200015	3,76			
20	200200020	4,73			
25	200200025	5,59			
32	200200032	7,12			
40	200200040	8,61			
50	200200050	10,68			
65	200200065	13,08			
100	200200100	17,48			
125	200200125	23,70			
150	200200150	28,62			
200	200200200	40,02			
250	200200250	51,67			
300	200200300	59,83			
350	200200350	92,41			
400	200200400	125,10			
450	200200450	152,29			
500	200200500	184,41			
600	200200600	221,96			
			80	200210080	16,58
			200	200210200	40,02
			250	200210250	57,24
			300	200210300	74,33
			350	200210350	122,12
			400	200210400	131,96
			450	200210450	200,21
			500	200210500	230,77
			600	200210600	304,97



CIEGAS PN10 (DIN 2527)			CIEGAS PN16 (DIN 2527)		
DN	CODIGO	P.V.P.	DN	CODIGO	P.V.P.
15	200300015	3,26			
20	200300020	4,53			
25	200300025	5,57			
32	200300032	8,03			
40	200300040	9,32			
50	200300050	12,82			
65	200300065	16,32			
100	200300100	25,12			
125	200300125	37,43			
150	200300150	46,10			
200	200300200	73,30			
250	200300250	106,58			
300	200300300	137,14			
350	200300350	180,26			
400	200300400	219,50			
450	200300450	288,66			
500	200300500	333,20			
600	200300600	446,26			
			80	200310080	21,37
			200	200310200	74,20
			250	200310250	110,72
			300	200310300	156,18
			350	200310350	212,38
			400	200310400	282,96
			450	200310450	374,26
			500	200310500	453,25
			600	200310600	651,39





UNIONES GIBALT PARA TUBO DE PVC

UNION GIBALT PARA PVC GG-25

DN	CODIGO	P.V.P.
50	280100050	8,12
63	280100063	9,68
75	280100075	11,32
90	280100090	13,57
110	280100110	18,86
125	280100125	21,83
140	280100140	24,14
160	280100160	29,58
180	280100180	38,44
200	280100200	54,28
250	280100250	73,19
315	280100315	95,37
400	280100400	123,67
500	280100500	163,89



UNION GIBALT PARA PVC GGG-50

DN	CODIGO	P.V.P.
63	280200063	17,81
75	280200075	22,10
90	280200090	26,47
110	280200110	32,37
125	280200125	34,18
140	280200140	51,07
160	280200160	56,43
200	280200200	81,78
250	280200250	121,25
315	280200315	149,66



ARO LATERAL UNION GIBALT

DN	CODIGO	P.V.P.
63	280000063	2,34
75	280000075	3,40
90	280000090	4,32
110	280000110	4,53
125	280000125	4,88
140	280000140	6,85
160	280000160	7,62
180	280000180	10,05
200	280000200	11,76
250	280000250	18,78
315	280000315	27,96
400	280000400	34,14
500	280000500	56,72



GOMA PARA UNION GIBALT PVC

DN	CODIGO	P.V.P.
63	470100063	0,85
75	470100075	0,96
90	470100090	1,15
110	470100110	1,30
125	470100125	1,52
140	470100140	1,63
160	470100160	1,78
180	470100180	2,37
200	470100200	2,96
250	470100250	3,70
315	470100315	4,59



UNION GIBALT CASQUILLO DE PVC

DN	CODIGO	P.V.P.
63	280150063	24,75
75	280150075	31,50
90	280150090	36,00
110	280150110	51,75
125	280150125	57,38
140	280150140	60,75
160	280150160	67,50
180	280150180	78,75
200	280150200	117,00
250	280150250	231,75
315	280150315	342,00





COLLARINES DE FUNDICION

PARA TUBO DE PVC - 2 TORNILLOS							
DN	ROSCA	CODIGO	P.V.P.	DN	ROSCA	CODIGO	P.V.P.
40	3/4"	230300040	4,38	200	1"	230400200	24,28
50	3/4"	230300050	5,80	200	1 1/4"	230500200	24,56
50	1"	230400050	5,80	200	1 1/2"	230600200	24,79
63	3/4"	230300063	6,34	200	2"	230700200	25,54
63	1"	230400063	6,34	200	2 1/2"	230800200	25,69
63	1 1/4"	230500063	6,34	200	3"	230900200	25,96
75	3/4"	230300075	6,89	250	1"	230400250	32,84
75	1"	230400075	6,89	250	1 1/4"	230500250	34,76
75	1 1/4"	230500075	7,65	250	1 1/2"	230600250	35,06
90	3/4"	230300090	7,59	250	2"	230700250	35,25
90	1"	230400090	7,59	250	2 1/2"	230800250	35,48
90	1 1/4"	230500090	8,34	250	3"	230900250	35,83
90	1 1/2"	230600090	12,11	315	2"	230700315	49,95
90	2"	230700090	12,59	315	2 1/2"	230800315	52,91
110	3/4"	230300110	10,15	315	3"	230900315	53,22
110	1"	230400110	10,15				
110	1 1/4"	230500110	10,90				
110	1 1/2"	230600110	14,46				
110	2"	230700110	14,62				
110	2 1/2"	230800110	16,94				
125	3/4"	230300125	13,99				
125	1"	230400125	13,99				
125	1 1/4"	230500125	14,74				
125	1 1/2"	230600125	17,21				
125	2"	230700125	17,73				
125	2 1/2"	230800125	19,63				
125	3"	230900125	19,96				
140	1"	230400140	17,61				
140	1 1/4"	230500140	18,36				
140	1 1/2"	230600140	19,66				
140	2"	230700140	20,44				
140	2 1/2"	230800140	21,37				
140	3"	230900140	21,69				
160	1"	230400160	18,49				
160	1 1/4"	230500160	19,25				
160	1 1/2"	230600160	20,69				
160	2"	230700160	21,47				
160	2 1/2"	230800160	21,77				
160	3"	230900160	22,11				





COLLARINES DE FUNDICION

PARA TUBO DE PVC/PE - 4 TORNILLOS							
DN	ROSCA	CODIGO	P.V.P.	DN	ROSCA	CODIGO	P.V.P.
40	3/4"	240300040	12,55	200	1"	240400200	62,01
40	1"	240400040	12,55	200	1 1/4"	240500200	62,01
50	3/4"	240300050	12,91	200	1 1/2"	240600200	62,01
50	1"	240400050	12,91	200	2"	240700200	68,21
63	3/4"	240300063	15,98	200	2 1/2"	240800200	68,21
63	1"	240400063	15,98	200	3"	240900200	68,21
63	1 1/4"	240500063	17,12	250	2"	240700250	117,94
63	1 1/2"	240600063	17,12	315	2"	240700315	135,21
63	2"	240700063	17,62				
75	3/4"	240300075	18,09				
75	1"	240400075	18,09				
75	1 1/4"	240500075	18,52				
75	1 1/2"	240600075	18,52				
75	2"	240700075	18,52				
90	3/4"	240300090	19,92				
90	1"	240400090	19,92				
90	1 1/4"	240500090	21,28				
90	1 1/2"	240600090	21,28				
90	2"	240700090	21,28				
110	3/4"	240300110	24,34				
110	1"	240400110	24,34				
110	1 1/4"	240500110	26,72				
110	1 1/2"	240600110	26,72				
110	2"	240700110	26,72				
125	3/4"	240300125	30,44				
125	1"	240400125	30,44				
125	1 1/4"	240500125	30,44				
125	1 1/2"	240600125	30,44				
125	2"	240700125	30,44				
140	1"	240400140	38,18				
140	1 1/4"	240500140	38,18				
140	1 1/2"	240600140	38,18				
140	2"	240700140	38,18				
160	3/4"	240600160	45,46				
160	1"	240400160	45,46				
160	1 1/4"	240500160	45,46				
160	1 1/2"	240600160	45,46				
160	2"	240700160	51,71				
160	2 1/2"	240800160	54,18				
160	3"	240900160	54,18				



BOCAS DE RIEGO

TIPO MADRID

DESCRIPCIÓN	CODIGO	P.V.P.
ER 45	320100645	98,95
Rosca Madrid	320100611	116,66
Rosca Zaragoza	320100613	116,66
Rosca Granada	320100614	116,66
Rosca Santander	320100615	116,66
Rosca Burgos	320100616	116,66
Rosca Manzanares	320100617	116,66
Rosca Segovia	320100618	116,66
Rosca Talavera	320100619	116,66



TIPO BARCELONA

DESCRIPCIÓN	CODIGO	P.V.P.
ER 45	320200645	98,95
Rosca Madrid	320200611	116,66
Rosca Zaragoza	320200613	116,66
Rosca Granada	320200614	116,66
Rosca Santander	320200615	116,66
Rosca Burgos	320200616	116,66
Rosca Manzanares	320200617	116,66
Rosca Segovia	320200618	116,66
Rosca Talavera	320200619	116,66



TIPO ZARAGOZA

DESCRIPCIÓN	CODIGO	P.V.P.
ER 45	320300645	118,75
Rosca Zaragoza	320300613	118,75
Rosca Palencia	320300622	137,50



TIPO GRANADA

DESCRIPCIÓN	CODIGO	P.V.P.
Conjunto de Bronce	320400001	163,80
Boca riego Granada	320400614	210,00



ACCESORIOS BOCA RIEGO

DESCRIPCIÓN	CODIGO	P.V.P.
Colzada recta c/oreja	430100000	72,06
Colzada curva c/oreja	430200000	85,59
Base c/oreja	430300000	57,88
Junta para base	430400000	1,22





ACCESORIOS DE LATON PARA TUBO POLIETILENO ROSCA EXTERIOR

RACOR RECTO MACHO			RACOR RECTO HEMBRA			
ROSCA	CODIGO	P.V.P.		ROSCA	CODIGO	P.V.P.
20-1/2"	370130020	2,64		20-1/2"	370230020	2,80
25-3/4"	370130025	3,75		25-3/4"	370230025	4,17
32-1"	370130032	5,71		32-1"	370230032	6,05
40-1 1/4"	370130040	9,70		40-1 1/4"	370230040	10,21
50-1 1/2"	370130050	13,60		50-1 1/2"	370230050	15,22
63-2"	370130063	22,70		63-2"	370230063	26,63

RACOR RECTO DOBLE			RACOR CODO DOBLE			
ROSCA	CODIGO	P.V.P.		ROSCA	CODIGO	P.V.P.
20-1/2"	460300020	4,42		20-1/2"	420130020	4,89
25-3/4"	460300025	6,90		25-3/4"	420130025	7,55
32-1"	460300032	9,21		32-1"	420130032	11,73
40-1 1/4"	460300040	15,09		40-1 1/4"	420130040	19,64
50-1 1/2"	460300050	21,41		50-1 1/2"	420130050	29,16
63-2"	460300063	35,93		63-2"	420130063	46,42

RACOR CODO MACHO			RACOR CODO HEMBRA			
ROSCA	CODIGO	P.V.P.		ROSCA	CODIGO	P.V.P.
20-1/2"	420230020	3,70		20-1/2"	420330020	3,56
25-3/4"	420230025	5,40		25-3/4"	420330025	5,43
32-1"	420230032	9,49		32-1"	420330032	9,17
40-1 1/4"	420230040	14,39		40-1 1/4"	420330040	15,02
50-1 1/2"	420230050	20,92		50-1 1/2"	420330050	21,50
63-2"	420230063	33,49		63-2"	420330063	38,58

RACOR EN T			RACOR EN T HEMBRA			
ROSCA	CODIGO	P.V.P.		ROSCA	CODIGO	P.V.P.
20-1/2"	400130020	7,18		20-1/2"	400330020	5,55
25-3/4"	400130025	10,84		25-3/4"	400330025	8,52
32-1"	400130032	16,53		32-1"	400330032	12,64
40-1 1/4"	400130040	26,52		40-1 1/4"	400330040	21,82
50-1 1/2"	400130050	42,01		50-1 1/2"	400330050	35,52
63-2"	400130063	69,64		63-2"	400330063	63,07

RACOR CODO PLACA HEMBRA		
ROSCA	CODIGO	P.V.P.
20-1/2"	420620020	5,54
25-3/4"	420620025	7,72
32-1"	420620032	12,29





ACCESORIOS DE LATON PARA TUBO DE POLIETILENO CON BRIDAS

RACOR RECTO MACHO

ROSCA	CODIGO	P.V.P.
75-2 1/2"	370110075	53,86
90-3"	370110090	65,52



RACOR RECTO HEMBRA

ROSCA	CODIGO	P.V.P.
75-2 1/2"	370210075	53,46
90-3"	370210090	70,64



RACOR RECTO DOBLE

ROSCA	CODIGO	P.V.P.
75-2 1/2"	460100075	89,09
90-3"	460100090	105,96



RACOR CODO DOBLE

ROSCA	CODIGO	P.V.P.
75-2 1/2"	420110075	109,78
90-3"	420110090	149,16



RACOR CODO MACHO

ROSCA	CODIGO	P.V.P.
75-2 1/2"	420210075	72,61
90-3"	420210090	95,39



RACOR CODO HEMBRA

ROSCA	CODIGO	P.V.P.
75-2 1/2"	420310075	70,77
90-3"	420310090	99,57



RACOR EN T

ROSCA	CODIGO	P.V.P.
75-2 1/2"	400110075	143,53
90-3"	400110090	197,84



RACOR EN T HEMBRA

ROSCA	CODIGO	P.V.P.
75-2 1/2"	400310075	116,75
90-3"	400310090	165,77





VALVULAS DE LATON

VALVULA DE ESFERA C/PALANCA

ROSCA	CODIGO	P.V.P.
1/4"	140100010	3,88
3/8"	140100015	3,92
1/2"	140100020	3,04
3/4"	140100025	4,17
1"	140100032	6,86
1 1/4"	140100040	11,04
1 1/2"	140100050	15,75
2"	140100063	24,26
2 1/2"	140100075	72,97
3"	140100090	105,05
4"	140100110	148,75



VALVULA DE ESFERA C/PALANCA INOX

ROSCA	CODIGO	P.V.P.
1/2"	140110020	6,43
3/4"	140110025	7,86
1"	140110032	12,86
1 1/4"	140110040	20,71
1 1/2"	140110050	28,57
2"	140110063	40,00

VALVULA DE ESFERA C/CUADRADILLO

ROSCA	CODIGO	P.V.P.
1/2"	140300020	8,03
3/4"	140300025	9,45
1"	140300032	12,60
1 1/4"	140300040	18,15
1 1/2"	140300050	25,05
2"	140300063	37,88



VALVULA DE ESFERA C/PALOMETA

ROSCA	CODIGO	P.V.P.
1/2"	140400020	3,48
3/4"	140400025	4,83
1"	140400032	7,70



GRIFO DE ESFERA R/MANGUERA

ROSCA	CODIGO	P.V.P.
1/2" - 3/4"	380100020	3,90
3/4" - 1"	380100025	5,20
1" - 1 1/4"	380100032	11,13



GRIFO ESFERA E/RAPIDO C/PALANCA INOX

ROSCA	CODIGO	P.V.P.
1/2" - 3/4"	380110020	6,88
3/4" - 3/4"	380110025	8,13





<u>INDICE COMERCIAL</u>	<u>PAG</u>
Abrazaderas de Latón	43
Accesorios de PVC Presión Encolar	37-38
Accesorios de Fundición para PVC	69-70-71
Accesorios de PE para Soldadura a Tope	53-54
Accesorios Electrosoldable	51-52
Accesorios Fitting de PE para Tubería de PE	35-36
Accesorios Galvanizado roscado	45-48
Accesorios Inoxidable roscado	49-50
Accesorios para Tubería de Fundición (Brida y Enchufe)	61-68
Accesorios para Tubería de PE (Serie 1 / Serie 7)	33-34
Adhesivo para PVC de Presión	31
Bandas de Acero INOX para Collarín Universal	25
Bridas Enchufe para PVC	25
Bridas Multidiametro	24
Cabezal de Collarín Universal (Brida y Roscado)	25
Camara de descarga Automática de Fundición	58
Cañamo	31
Collarín de Fundición para Fibrocemento (2 Torn.)	56
Collarín de Latón	42
Collarín de Polipropileno reforzado para PE	55
Collarín para PVC/PE salida brida	26
Contadores (Brida y Roscados)	21
Denso	31
Filtros en "Y" roscados de latón	30
Filtros para agua potable	43
Grifos de Esfera de Latón	28
Hidrantes	58
Hilo sellador	31
Juegos de Registro	59-60
Juegos de Rejilla	59
Juntas de Neopreno	31
Latón Desmontable rosca Interior para PE	44
Latón Roscado	39-43
Limpiador para PVC	31
Lubricante para Juntas Elásticas	31
Malla Acero Inoxidable roscada	30
Manómetros	30
Paté de pozo	31
Puertas de Contador de Aluminio	27
Reductores de Presión de Latón	29
Sumideros	27
Teflón	31
Tornillería	32
Trampillones de Acera	60
Uniones ARPOL	72-73
Uniones Gibault para Fibrocemento	57
Uniones Multidiametro	24
Uniones Universales Gran Tolerancia	23
Valvulas de Bola de PVC	38
Válvulas de Compuerta de Latón	29
Valvulas de Esfera de Latón	28
Válvulas de Flotador	30
Válvulas de Pie	21
Válvulas de Puente	21
Válvulas de Retención de Latón	29
Ventosas	22



CONTADORES

ROSCADOS			BRIDAS		
ROSCA	CODIGO	P.V.P.	DN	CODIGO	P.V.P.
1/2"	590100002	79,14	50	590250050	364,32
3/4"	590100003	81,45	65	590250065	382,03
1"	590100004	133,56	80	590250080	436,10
1 1/4"	590100005	160,30	100	590250100	488,95
1 1/2"	590100006	277,97	125	590250125	590,40
2"	590100007	402,85	150	590250150	903,96
			200	590250200	1188,65



VALVULAS DE FUNDICION

PIE MALLA INOX		
DN	CODIGO	P.V.P.
80	170100080	297,68
100	170100100	352,80
125	170100125	458,33
150	170100150	540,23
200	170100200	773,33
250	170100250	1043,52
300	170100300	2650,73



PUENTE		
DN	CODIGO	P.V.P.
80	180100080	216,08
100	180100100	275,76
150	180100150	348,13
200	180100200	414,84
250	180100250	544,42
300	180100300	682,02

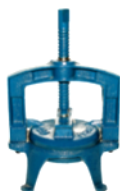



VENTOSAS

DOBLE EFECTO			TRIPLE EFECTO		
DN	CODIGO	P.V.P.	DN	CODIGO	P.V.P.
40	190100040	205,80	50	190110050	420,00
50	190100050	270,90	65	190110065	478,80
65	190100065	329,70	80	190110080	621,60
80	190100080	447,30	100	190110100	827,40
100	190100100	653,10	150	190110150	2276,40
150	190100150	1908,90			



ARI BASE BRONCE TRIPLE EFECTO			ARI BASE PLASTICO TRIPLE EFECTO		
ROSCA	CODIGO	P.V.P.	ROSCA	CODIGO	P.V.P.
1"	190300032	147,48	1"	190310032	116,34
2"	190300063	361,20	2"	190310063	254,06



POLIAMIDA BASE BRONCE			POLIAMIDA BASE PLASTICO		
ROSCA	CODIGO	P.V.P.	ROSCA	CODIGO	P.V.P.
1" (*)	190400032	62,27	1" (*)	190410032	35,34
2" (**)	190400063	138,01	2" (**)	190410063	92,57
1" (**)	190401032	92,57	1" (**)	190411032	48,81



(*) Doble efecto

(**) Triple efecto

JAIN BASE PLASTICO TRIPLE EFECTO		
ROSCA	CODIGO	P.V.P.
1"	190600032	30,19
2"	190600063	70,37





UNIONES UNIVERSALES GRAN TOLERANCIA

UNION UNIVERSAL GRAN TOLERANCIA

RANGO	CODIGO	P.V.P.	
57-72	68-85	280801500	163,80
57-72	85-102	280801501	178,50
68-85	85-102	280801502	186,90
68-85	103-116	280801503	231,00
85-102	103-116	280801504	233,10
85-102	108-128	280801505	266,70
85-102	128-146	280801506	291,90
103-116	108-128	280801507	268,80
103-116	128-146	280801508	277,20
103-116	134-154	280801509	281,40
108-128	128-146	280801510	285,60
108-128	134-154	280801511	291,90
108-128	154-175	280801512	315,00
128-146	134-154	280801513	302,40
128-146	154-175	280801514	323,40
128-146	165-182	280801515	336,00
134-154	154-175	280801516	348,60
134-154	165-182	280801517	344,40
154-175	165-182	280801518	352,80
154-175	185-207	280801519	375,90
165-182	185-207	280801520	386,40
165-182	208-225	280801521	434,70
165-182	218-236	280811521	554,40
184-207	208-225	280801522	480,90
184-207	225-250	280801523	508,20



RANGO	CODIGO	P.V.P.	
208-225	225-250	280801524	510,30
208-225	246-266	280801525	535,50
225-250	246-266	280801526	569,10
225-250	264-284	280801527	609,00
222-250	282-302	280811527	774,90
246-266	264-284	280801528	663,60
246-266	282-302	280801529	703,50
246-266	305-326	280801530	724,50
264-284	282-302	280801531	730,80
264-284	305-326	280801532	735,00
264-284	315-335	280801533	760,20
282-302	305-326	280801534	774,90
282-302	315-335	280801535	791,70
282-302	334-352	280801536	840,00
305-326	315-335	280801537	812,70
305-326	334-352	280801538	770,70
305-326	360-386	280801539	777,00
315-335	334-352	280801540	783,30
315-335	360-386	280801541	787,50
360-386	386-410	280801544	873,60
360-386	408-435	280801545	913,50
360-386	425-458	280801546	995,40
386-410	408-435	280801547	997,50
386-410	425-458	280801548	1016,40
408-435	425-458	280801549	1089,90
408-435	465-500	280801550	1094,10
425-458	465-500	280801551	1192,80



BRIDAS Y UNIONES MULTIDIAMETRO

BRIDA MULTIDIAMETRO

RANGO	DN	CODIGO	P.V.P.
40-75	50	200800040	132,30
60-95	60-65	200800060	161,70
80-115	80	200800080	201,60
105-135	100	200800105	222,60
130-165	125	200800130	279,30
155-195	150	200800155	315,00
190-230	175	200800190	369,60
215-258	200	200800215	405,30
240-280	225	200800240	453,60
235-275	250	200800235	466,20
270-310	250	200800270	552,30
310-350	300	200800310	615,30
350-390	300	200800350	764,40
350-390	350	200800351	793,80
395-435	350	200800395	863,10
400-435	400	200800400	915,60
435-470	400	200800435	993,30
470-505	400	200800470	1123,50
455-490	450	200800455	1331,40
490-525	450	200800490	1381,80
505-540	500	200800505	1436,40
540-575	500	200800540	1759,80
575-610	500	200800575	1845,90
610-645	600	200800610	1732,50
645-680	600	200800645	2226,00
680-715	600	200800680	2297,40
710-745	700	200800710	2457,00
810-845	800	200800810	2580,90



UNION MULTIDIAMETRO

RANGO	CODIGO	P.V.P.
40-75	280800040	168,00
60-95	280800060	214,20
80-115	280800080	231,00
105-135	280800105	266,70
130-165	280800130	336,00
155-195	280800155	348,60
190-230	280800190	386,40
215-258	280800215	491,40
235-275	280800235	495,60
240-280	280800240	567,00
270-310	280800270	535,50
310-350	280800310	606,90
350-390	280800350	686,70
395-435	280800395	871,50
435-470	280800435	1005,90
470-505	280800470	1272,60
505-540	280800505	1463,70
540-575	280800540	1518,30
575-610	280800575	1591,80
610-645	280800610	1646,40
645-680	280800645	1782,90
680-715	280800680	1833,30
710-745	280800710	1980,30
810-845	280800810	2217,60





COLLARIN UNIVERSAL

SALIDA ROSCADA			SALIDA BRIDA		
ROSCA	CODIGO	P.V.P.	DN	CODIGO	P.V.P.
3/4" (1)	730200003	35,14	50 (2)	730100050	87,00
1" (1)	730200004	35,14	65 (2)	730100065	102,00
1 1/4" (1)	730200005	43,92	80 (2)	730100080	144,00
1 1/2" (1)	730200006	43,92	100 (2)	730100100	172,50
2" (1)	730200007	46,12	125 (2)	730100125	246,00
2 1/2" (2)	730200008	68,08	150 (3)	730100150	376,50
3" (2)	730200009	83,45			



(*) N° Bandas

BANDAS INOXIDABLES					
RANGO	CODIGO	P.V.P.	RANGO	CODIGO	P.V.P.
050/075	740050075	42,91	340/360	740340360	75,81
075/105	740075105	45,41	360/380	740360380	78,11
105/130	740105130	48,88	380/400	740380400	96,25
130/155	740130155	50,42	400/420	740400420	102,09
155/180	740155180	52,59	420/440	740420440	107,49
180/200	740180200	55,87	440/460	740440460	112,92
200/220	740200220	57,43	450/470	740450470	112,92
220/240	740220240	58,98	470/490	740470490	121,86
240/260	740240260	63,46	490/510	740490510	129,76
260/280	740260280	65,90	525/545	740525545	137,32
280/300	740280300	68,65	625/645	740625645	175,94
300/320	740300320	71,15	710/725	740710725	175,94
320/340	740320340	73,50	830/850	740830850	230,84
			ALARGADERA	740000000	20,28



BRIDAS ENCHUFE

PARA PVC					
DN	CODIGO	P.V.P.	DN	CODIGO	P.V.P.
50x63	200910063	40,08	200x200	200910200	113,37
65x75	200910075	41,55	250x250	200910250	221,34
80x90	200910090	52,05	300x315	200910315	341,71
100x110	200910110	58,49	400x400	200910400	543,38
125x125	200910125	72,38	500x500	200910500	678,79
125x140	200910140	72,77	600x630	200910630	1287,48
150x160	200910160	89,39	700x710	200910710	1523,27
150x180	200910180	92,72	800x800	200910800	1937,01





COLLARIN SALIDA BRIDA PARA TUBO PVC/PE

SALIDA BRIDA PARA PVC/PE							
TUBO	DN	CODIGO	P.V.P.	TUBO	DN	CODIGO	P.V.P.
90	40	760040090	153,95	355	80	760080355	943,19
90	50	760050090	153,95	355	100	760100355	996,77
90	80	760080090	174,23	355	150	760150355	1070,16
110	40	760040110	162,14	400	50	760050400	928,27
110	50	760050110	162,14	400	80	760080400	971,01
110	65	760065110	182,35	400	100	760100400	1020,73
110	80	760080110	192,75	400	150	760150400	1096,25
125	40	760040125	176,36	500	100	760100500	1533,28
125	50	760050125	176,36	500	150	760150500	1568,86
125	65	760065125	190,99	500	200	760200500	1623,98
125	80	760080125	204,95	630	100	760100630	1833,68
125	100	760100125	212,23	630	150	760150630	1924,12
140	40	760040140	192,50	630	200	760200630	2014,52
140	50	760050140	192,50				
140	65	760065140	202,05				
140	80	760080140	222,01				
160	40	760040160	238,69				
160	50	760050160	238,69				
160	65	760065160	257,47				
160	80	760080160	285,29				
160	100	760100160	294,37				
180	40	760040180	289,55				
180	80	760080180	303,15				
180	100	760100180	312,74				
180	150	760150180	415,94				
200	40	760040200	282,61				
200	50	760050200	282,61				
200	65	760065200	292,64				
200	80	760080200	313,04				
200	100	760100200	315,79				
200	150	760150200	427,40				
225	80	760080225	393,04				
225	100	760100225	402,93				
250	40	760040250	475,32				
250	50	760050250	475,32				
250	80	760080250	504,06				
250	100	760100250	517,15				
250	150	760150250	598,44				
315	50	760050315	703,80				
315	80	760080315	721,40				
315	100	760100315	719,71				
315	150	760150315	798,58				





SUMIDEROS / PUERTAS DE CONTADOR

ACERO CINCADO			ACERO INOXIDABLE			
DN	CODIGO	P.V.P.		DN	CODIGO	P.V.P.
80x80	350100080	12,16		80x80	350200080	22,71
100x100	350100100	15,84		100x100	350200100	26,12
125x125	350100125	19,06		125x125	350200125	37,83
150x150	350100150	24,51		150x150	350200150	59,47
200x200	350100200	32,32		200x200	350200200	90,05
250x250	350100250	52,61		250x250	350200250	130,26
300x300	350100300	74,20		300x300	350200300	181,44

FUNDICION TIPO CAMPANA			ALUMINIO			
DN	CODIGO	P.V.P.		DN	CODIGO	P.V.P.
150x150	350300150	8,57		150x150	350600150	11,05
200x200	350300200	15,08		200x200	350600200	15,07
250x250	350300250	21,49		250x250	350600250	20,95
300x300	350300300	30,96		300x300	350600300	27,98
400x400	350300400	63,58		400x400	350600400	62,65

CERRADURA Y LLAVE			CUADRADO TAPA CIRCULAR			
DN	CODIGO	P.V.P.		DN	CODIGO	P.V.P.
35x22	360113522	19,63		20x20	360502020	13,68
40x30	360114030	23,62				
50x26	360115026	39,11				
44x46	360114446	62,86				



VALVULAS DE LATON

VALVULA DE ESFERA ANTIRETORNO

ROSCA	CODIGO	P.V.P.
1/2"	140200020	10,08
3/4"	140200025	15,52
1"	140200032	25,21
1 1/4"	140200040	79,97
1 1/2"	140200050	141,12
2"	140200063	206,64



VALVULA DE ESFERA C/PALOMETA M/H

ROSCA	CODIGO	P.V.P.
1/2"	140500020	4,86
3/4"	140500025	6,80
1"	140500032	10,98



VALVULA ASIEN TO INCLINADO

ROSCA	CODIGO	P.V.P.
1/2"	120400020	10,82
3/4"	120400025	15,33
1"	120400032	24,77
1 1/4"	120400040	40,57
1 1/2"	120400050	54,98
2"	120400063	87,86



GRIFO RACOR MANGUERA

ROSCA	CODIGO	P.V.P.
1/2"	380300020	12,36
3/4"	380300025	17,13
1"	380300032	21,76



GRIFO FUENTE CROMADO (PLATA)

ROSCA	CODIGO	P.V.P.
1/2"	380200020	60,85
3/4"	380200025	70,80
1"	380200032	70,69



GRIFO FUENTE PULIDO (ORO)

ROSCA	CODIGO	P.V.P.
1/2"	380210020	50,71
3/4"	380210025	59,00
1"	380210032	58,91



BEBEDERO PARA CERDOS (LATON + INOX)

ROSCA	CODIGO	P.V.P.
1/2"	380400010	4,70



BEBEDERO PARA CERDOS (INOX)

ROSCA	CODIGO	P.V.P.
1/2"	380400015	8,93





VALVULAS DE LATON

COMPUERTA CIERRE METAL

ROSCA	CODIGO	P.V.P.
1/2"	120300020	5,95
3/4"	120300025	6,98
1"	120300032	10,24
1 1/4"	120300040	15,83
1 1/2"	120300050	23,29
2"	120300063	35,76
2 1/2"	120300075	56,32
3"	120300090	78,40
4"	120300110	137,80



COMPUERTA CIERRE ELASTICO

ROSCA	CODIGO	P.V.P.
1/2"	120310020	8,80
3/4"	120310025	11,60
1"	120310032	17,10
1 1/4"	120310040	27,31
1 1/2"	120310050	34,27
2"	120310063	53,72

RETENCION MODELO YORK

ROSCA	CODIGO	P.V.P.
1/2"	160300020	5,03
3/4"	160300025	7,67
1"	160300032	9,70
1 1/4"	160300040	14,60
1 1/2"	160300050	22,06
2"	160300063	32,16
2 1/2"	160300075	69,18
3"	160300090	93,49
4"	160300110	148,37



RETENCION CLAPETA CIERRE ELASTICO

ROSCA	CODIGO	P.V.P.
1/2"	160500020	6,79
3/4"	160500025	9,56
1"	160500032	13,65
1 1/4"	160500040	20,83
1 1/2"	160500050	27,86
2"	160500063	47,60
2 1/2"	160500075	74,06
3"	160500090	112,04



REDUCTORA DE PRESION

ROSCA	CODIGO	P.V.P.
1/2"	390100020	38,77
3/4"	390100025	62,40
1"	390100032	72,47
1 1/4"	390100040	152,62
1 1/2"	390100050	157,47
2"	390100063	250,82
2 1/2"	390100075	359,93
3"	390100090	532,47





VALVULAS DE LATON

FILTRO LATON MALLA INOX

ROSCA	CODIGO	P.V.P.
1/2"	150200020	4,50
3/4"	150200025	6,62
1"	150200032	9,18
1 1/4"	150200040	19,48
1 1/2"	150200050	25,49
2"	150200063	53,21
2 1/2"	150200075	73,33
3"	150200090	87,48
4"	150200110	148,39



MALLA INOX

ROSCA	CODIGO	P.V.P.
1/2"	010100002	0,61
3/4"	010100003	0,74
1"	010100004	1,00
1 1/4"	010100005	1,59
1 1/2"	010100006	2,05
2"	010100007	2,54
2 1/2"	010100008	4,69
3"	010100009	5,84
4"	010100010	8,62

FLOTADOR PVC VARILLA INOX

ROSCA	CODIGO	P.V.P.
1/2"	890400020	17,21
3/4"	890400025	19,13
1"	890400032	30,57



FLOTADOR LATON BOYA PVC

ROSCA	CODIGO	P.V.P.
1/2"	890420020	17,55
3/4"	890420025	26,82
1"	890420032	38,36
1 1/4"	890420040	70,91
1 1/2"	890420050	80,97
2"	890420063	124,05



MANOMETRO GLICERINA 1/4" - 63MM

Bar.	CODIGO	P.V.P.
0-2,5	450100002	10,77
0-4	450100004	10,77
0-6	450100006	10,77
0-10	450100010	10,77
0-16	450100016	10,77



MANOMETRO GLICERINA 1/2" - 100MM

Bar.	CODIGO	P.V.P.
0-2,5	450200002	23,66
0-4	450200004	23,66
0-6	450200006	23,66
0-10	450200010	23,66
0-16	450200016	23,66



JUNTAS PARA BRIDAS

ADHESIVAS			TALADRADAS		
DN	CODIGO	P.V.P.	DN	CODIGO	P.V.P.
40	220100040	0,50	40	220200040	0,98
50	220100050	0,58	50	220200050	1,17
65	220100065	0,65	65	220200065	1,40
80	220100080	0,83	80	220200080	1,64
100	220100100	1,12	100	220200100	1,97
125	220100125	1,62	125	220200125	2,53
150	220100150	1,94	150	220200150	3,18
200	220100200	3,10	200	220200200	4,45
250	220100250	4,43	250	220200250	6,02
300	220100300	6,19	300	220200300	8,78
350	220100350	8,39	350	220200350	14,04
400	220100400	10,33	400	220200400	17,63
450	220100450	12,06	450	220200450	23,35
500	220100500	14,98	500	220200500	27,73
600	220100600	20,27	600	220200600	33,53



VARIOS

TEFLON			CAÑAMO		
DN	CODIGO	P.V.P.	PESO	CODIGO	P.V.P.
12x12x075	490100000	0,44	250 gr	490100005	4,48
50x19x0,1	490100001	3,94			



ADHESIVO PVC			HILO SELLADOR		
ML	CODIGO	P.V.P.	LONGITUD	CODIGO	P.V.P.
125 ml	810000007	3,38	150 m.	490100010	24,28
1000 ml	810000000	17,81			



LIMPIADOR PVC			LUBRICANTE JUNTAS ELASTICAS		
ML	CODIGO	P.V.P.	PESO	CODIGO	P.V.P.
1000 ml	810000001	10,20	1000 gr	810000008	9,34



DENSO			PATE DE POZO		
PESO	CODIGO	P.V.P.	MEDIDA	CODIGO	P.V.P.
1000 gr	490100002	21,00	340x230	490100006	6,86





TORNILLERIA CINCADA

TORNILLOS



Longitud	CODIGO	M-16	CODIGO	M-18	CODIGO	M-20
60	550116060	0,79	550118060	0,99	550120060	1,28
70	550116070	0,86	550118070	1,23	550120070	1,55
80	550116080	0,93	550118080	1,42	550120080	1,68
90	550116090	1,13	550118090	1,55	550120090	1,79
100	550116100	1,27	550118100	1,65	550120100	2,42
110	550116110	1,56	550118110	1,92	550120110	2,62
120	550116120	1,84	550118120	2,04	550120120	2,82
130	550116130	2,25	550118130	2,14	550120130	2,99
140	550116140	2,44	550118140	2,26	550120140	3,16
150	550116150	2,60	550118150	2,91	550120150	3,27
160	550116160	2,91	550118160	3,26	550120160	4,23
180	550116180	2,93	550118180	3,77	550120180	4,68
200	550116200	3,72	550118200	4,04	550120200	5,10



Longitud	CODIGO	M-22	CODIGO	M-24	CODIGO	M-27
60	550122060	1,56	550124060	2,78		
70	550122070	2,04	550124070	3,07		
80	550122080	2,48	550124080	3,44	550127080	4,60
90	550122090	2,93	550124090	3,61	550127090	4,73
100	550122100	3,38	550124100	4,27	550127100	5,67
110	550122110	3,62	550124110	4,59	550127110	5,80
120	550122120	3,94	550124120	4,91	550127120	5,92
130	550122130	4,27	550124130	5,31		
140	550122140	4,55	550124140	5,62		
150	550122150	4,84	550124150	5,97		
160	550122160	5,10	550124160	6,30		
180	550122180	5,67	550124180	6,96		
200	550122200	5,97	550124200	7,62	550127200	7,94



Metrica	TUERCAS		ARANDELAS		VARILLA (1000mm)	
	CODIGO	P.V.P.	CODIGO	P.V.P.	CODIGO	P.V.P.
16	560100016	0,23	560000016	0,11	570100016	5,83
18	560100018	0,33	560000018	0,13	570100018	6,91
20	560100020	0,42	560000020	0,16	570100020	9,61
22	560100022	0,60	560000022	0,23	570100022	10,98
24	560100024	0,82	560000024	0,30	570100024	13,82
27	560100027	1,34	560000027	0,41	570100027	19,35
30	560100030	1,96	560000030	0,53	570100030	24,70
33	560100033	2,38	560000033	0,97	570100033	30,94
39	560100039	4,68	560000039	1,34	570100039	43,88



ACCESORIOS DE COMPRESION PARA PE (SERIE 1 / SERIE 17)

RACOR RECTO MACHO

DN	CODIGO	P.V.P.
20-1/2"	500102002	2,97
20-3/4"	500102003	2,97
25-1/2"	500102502	3,34
25-3/4"	500102503	3,34
25-1"	500102504	3,34
32-3/4"	500103203	4,68
32-1"	500103204	3,95
32-1 1/4"	500103205	4,68
32-1 1/2"	500103206	5,47
32-2"	500103207	6,60
40-1"	500104004	8,70
40-1 1/4"	500104005	8,70
40-1 1/2"	500104006	8,70
50-1"	500105004	10,77
50-1 1/4"	500105005	10,77
50-1 1/2"	500105006	10,77
50-2"	500105007	10,77
63-1 1/2"	500106306	17,63
63-2"	500106307	17,63



RACOR RECTO HEMBRA

DN	CODIGO	P.V.P.
20-1/2"	500112002	2,97
20-3/4"	500112003	2,97
25-1/2"	500112502	3,34
25-3/4"	500112503	3,34
25-1"	500112504	3,34
32-3/4"	500113203	4,76
32-1"	500113204	4,76
32-1 1/4"	500113205	6,58
40-1"	500114004	11,39
40-1 1/4"	500114005	11,39
40-1 1/2"	500114006	11,94
50-1 1/4"	500115005	14,56
50-1 1/2"	500115006	14,56
50-2"	500115007	14,56
63-1 1/2"	500116306	21,55
63-2"	500116307	21,86

RACOR RECTO REDUCIDO

DN	CODIGO	P.V.P.
25 - 20	500312520	6,31
32 - 20	500313220	8,16
32 - 25	500313225	8,16
40 - 32	500314032	12,84
50 - 25	500315025	18,25
50 - 32	500315032	18,25
50 - 40	500315040	18,25
63 - 32	500316332	25,06
63 - 40	500316340	25,06
63 - 50	500316350	25,06

RACOR RECTO DOBLE

DN	CODIGO	P.V.P.
20	500300020	4,36
25	500300025	5,19
32	500300032	7,15
40	500300040	12,95
50	500300050	16,62
63	500300063	28,75



RACOR EN T

DN	CODIGO	P.V.P.
20	500200020	8,05
25	500200025	9,36
32	500200032	13,24
40	500200040	22,09
50	500200050	28,08
63	500200063	42,96



RACOR RECTO PE/COBRE

DN	CODIGO	P.V.P.
20 - 15	500602015	12,87
25 - 15	500602515	15,02
25 - 22	500602522	15,02
32 - 28	500603228	18,31
40 - 28	500604028	22,81

SERIE 17

DN	CODIGO	P.V.P.
24-28	500200020	51,69
31-35	500200025	63,11
40-43	500200032	77,52
48-51	500200040	92,85
60-64	500200050	123,80



LLAVE DESMONTAJE

DN	CODIGO	P.V.P.
20-32	500002032	16,50
40-63	500004063	41,04



ACCESORIOS DE COMPRESION PARA PE (SERIE 1)

RACOR CODO MACHO			RACOR CODO HEMBRA		
DN	CODIGO	P.V.P.	DN	CODIGO	P.V.P.
20-1/2"	509012002	3,40	20-1/2"	509022002	3,68
20-3/4"	509012003	3,40	20-3/4"	509022003	3,68
25-1/2"	509012502	3,56	20-1"	509022004	4,19
25-3/4"	509012503	3,56	25-1/2"	509022502	4,76
25-1"	509012504	3,56	25-3/4"	509022503	4,76
32-3/4"	509013203	5,47	25-1"	509022504	4,76
32-1"	509013204	5,47	32-3/4"	509023203	6,42
32-1 1/4"	509013205	6,12	32-1"	509023204	6,42
40-1"	509014004	11,56	32-1 1/4"	509023205	8,14
40-1 1/4"	509014005	11,56	40-1"	509024004	15,12
40-1 1/2"	509014006	11,56	40-1 1/4"	509024005	15,12
50-1 1/4"	509015005	14,34	40-1 1/2"	509024006	15,12
50-1 1/2"	509015006	14,34	50-1 1/2"	509025006	18,13
63-1 1/4"	509016305	19,75	50-2"	509025007	18,13
63-1 1/2"	509016306	19,75	63-2"	509026307	24,52
63-2"	509016307	19,75			



RACOR CODO DOBLE			TAPON		
DN	CODIGO	P.V.P.	DN	CODIGO	P.V.P.
20	509000020	5,01	20	500500020	2,82
25	509000025	5,63	25	500500025	3,34
32	509000032	7,64	32	500500032	4,68
40	509000040	15,29	40	500500040	8,70
50	509000050	20,20	50	500500050	10,77
63	509000063	31,52	63	500500063	17,63



RACOR RECTO MACHO LATON			RACOR RECTO HEMBRA LATON		
DN	CODIGO	P.V.P.	DN	CODIGO	P.V.P.
20-1/2"	500712002	20,15	20-1/2"	500722002	20,15
20-3/4"	500712003	20,15	20-3/4"	500722003	20,15
25-1/2"	500712502	21,98	25-1/2"	500722502	21,98
25-3/4"	500712503	21,98	25-3/4"	500722503	21,98
25-1"	500712504	21,98	25-1"	500722504	21,98
32-3/4"	500713203	25,39	32-3/4"	500723203	25,39
32-1"	500713204	25,39	32-1"	500723204	25,39
32-1 1/4"	500713205	27,11	32-1 1/4"	500723205	27,11
32-1 1/2"	500713206	27,11	40-3/4"	500724003	35,22
40-1"	500714004	35,20	40-1"	500724004	35,22
40-1 1/4"	500714005	35,20	40-1 1/4"	500724005	35,22
40-1 1/2"	500714006	35,20	40-1 1/2"	500724006	35,22
50-1 1/2"	500715006	48,33	50-1 1/2"	500725006	48,33
50-2"	500715007	48,33	50-2"	500725007	48,33
63-1 1/2"	500716306	66,57	63-1 1/2"	500726306	66,57
63-2"	500716307	66,57	63-2"	500726307	66,57





ACCESORIOS FITTING DE PE PARA TUBO POLIETILENO

RACOR RECTO MACHO			RACOR RECTO HEMBRA			
ROSCA	CODIGO	P.V.P.		ROSCA	CODIGO	P.V.P.
1/2"	370810020	1,24		1/2"	370820020	1,27
3/4"	370810025	1,45		3/4"	370820025	1,57
1"	370810032	2,11		1"	370820032	2,17
1 1/4"	370810040	3,01		1 1/4"	370820040	3,07
1 1/2"	370810050	4,40		1 1/2"	370820050	4,74
2"	370810063	7,00		2"	370820063	7,35
2 1/2"	370810075	13,42		2 1/2"	370820075	13,24
3"	370810090	20,58		3"	370820090	20,40
4"	370810110	48,50		4"	370820110	62,15

RACOR RECTO DOBLE			RACOR CODO DOBLE			
ROSCA	CODIGO	P.V.P.		ROSCA	CODIGO	P.V.P.
1/2"	460700020	1,90		1/2"	420800020	2,17
3/4"	460700025	2,35		3/4"	420800025	2,71
1"	460700032	3,40		1"	420800032	3,58
1 1/4"	460700040	5,02		1 1/4"	420800040	5,30
1 1/2"	460700050	7,47		1 1/2"	420800050	8,10
2"	460700063	11,64		2"	420800063	13,33
2 1/2"	460700075	20,78		2 1/2"	420800075	23,38
3"	460700090	32,33		3"	420800090	37,99
4"	460700110	84,92		4"	420800110	81,26

RACOR CODO MACHO			RACOR CODO HEMBRA			
ROSCA	CODIGO	P.V.P.		ROSCA	CODIGO	P.V.P.
1/2"	420810020	1,63		1/2"	420820020	1,80
3/4"	420810025	1,98		3/4"	420820025	2,26
1"	420810032	2,54		1"	420820032	2,86
1 1/4"	420810040	3,58		1 1/4"	420820040	3,88
1 1/2"	420810050	6,12		1 1/2"	420820050	6,67
2"	420810063	9,29		2"	420820063	9,71
2 1/2"	420810075	16,99		2 1/2"	420820075	18,91
3"	420810090	27,25		3"	420820090	28,43
4"	420810110	77,12		4"	420820110	78,40



ACCESORIOS FITTING DE PE PARA TUBO POLIETILENO

RACOR EN T			RACOR EN T HEMBRA			
ROSCA	CODIGO	P.V.P.		ROSCA	CODIGO	P.V.P.
1/2"	400700020	2,98		1/2"	400720020	2,21
3/4"	400700025	3,70		3/4"	400720025	2,79
1"	400700032	5,14		1"	400720032	4,00
1 1/4"	400700040	7,80		1 1/4"	400720040	5,82
1 1/2"	400700050	11,87		1 1/2"	400720050	8,76
2"	400700063	17,87		2"	400720063	13,27
2 1/2"	400700075	32,84		2 1/2"	400720075	24,42
3"	400700090	52,79		3"	400720090	37,44
4"	400700110	117,12		4"	400720110	83,46

RACOR RECTO DOBLE REDUCIDO			TAPON FINAL REGISTRABLE			
ROSCA	CODIGO	P.V.P.		ROSCA	CODIGO	P.V.P.
3/4"-1/2"	460750032	2,22		1/2"	060700020	1,69
1"-3/4"	460750043	3,04		3/4"	060700025	2,08
1 1/4"-1"	460750054	4,57		1"	060700032	2,80
1 1/2"-1 1/4"	460750065	6,51		1 1/4"	060700040	3,86
2"-1 1/2"	460750076	9,74		1 1/2"	060700050	4,51
2 1/2"-2"	460750087	17,80		2"	060700063	6,91
3"-2 1/2"	460750098	28,34		2 1/2"	060700075	13,27
4"-3"	460750109	81,37		3"	060700090	19,67
				4"	060700110	65,93

RACOR EN T MACHO			RACOR CODO PLACA HEMBRA			
ROSCA	CODIGO	P.V.P.		ROSCA	CODIGO	P.V.P.
1/2"	400710020	2,99		1/2"	420680020	2,26
3/4"	400710025	4,23		3/4"	420680025	2,59
1"	400710032	5,79		1"	420680032	3,58
				1 1/4"	420680040	4,85



ACCESORIOS PVC PRESION ENCOLAR

MANGUITO PORTABRIDAS			CODO			
DN	CODIGO	P.V.P.	DN	CODIGO	45°	90°
50	210100050	1,78	20	81**02020	0,58	0,42
63	210100063	1,88	25	81**02025	0,65	0,53
75	210100075	2,58	32	81**02032	0,98	0,88
90	210100090	3,31	40	81**02040	1,21	1,33
110	210100110	6,04	50	81**02050	1,63	1,85
125	210100125	8,06	63	81**02063	2,79	2,92
140	210100140	10,06	75	81**02075	4,75	5,23
160	210100160	13,51	90	81**02090	7,76	8,67
200	210100200	23,99	110	81**02110	15,06	15,06
250	210100250	35,21	125	81**02125	22,80	24,33
315	210100315	58,30	140	81**02140	38,05	43,12
			160	81**02160	45,65	46,93
			200	81**02200	66,78	73,83



TE IGUAL			MANGUITO		
DN	CODIGO	P.V.P.	DN	CODIGO	P.V.P.
20	810200020	0,53	20	810320020	0,48
25	810200025	0,65	25	810320025	0,56
32	810200032	1,00	32	810320032	0,65
40	810200040	1,75	40	810320040	1,00
50	810200050	2,54	50	810320050	1,35
63	810200063	3,64	63	810320063	2,19
75	810200075	6,96	75	810320075	4,50
90	810200090	11,36	90	810320090	4,77
110	810200110	19,67	110	810320110	9,27
125	810200125	34,03	125	810320125	14,24
140	810200140	56,00	140	810320140	23,65
160	810200160	59,19	160	810320160	25,84
200	810200200	90,25	200	810320200	46,96



TAPON			CRUZ		
DN	CODIGO	P.V.P.	DN	CODIGO	P.V.P.
20	810110020	0,42	20	810120020	2,74
25	810110025	0,46	25	810120025	3,19
32	810110032	0,63	32	810120032	3,60
40	810110040	1,21	40	810120040	4,87
50	810110050	1,51	50	810120050	6,33
63	810110063	1,79	63	810120063	11,00
75	810110075	4,10	75	810120075	16,25
90	810110090	5,07	90	810120090	21,57
110	810110110	11,40	110	810120110	32,35
125	810110125	17,76			
140	810110140	25,34			
160	810110160	27,87			
200	810110200	37,26			





ACCESORIOS PVC PRESION ENCOLAR

CASQUILLO REDUCIDO

DN	CODIGO	P.V.P.		DN	CODIGO	P.V.P.
25-20	814025020	0,42		110-50	814110050	6,25
32-20	814032020	0,46		110-63	814110063	6,25
32-25	814032025	0,46		110-75	814110075	6,25
40-25	814040025	0,68		110-90	814110090	6,25
40-32	814040032	0,68		125-75	814125075	9,66
50-20	814050020	0,75		125-90	814125090	9,66
50-25	814050025	0,75		125-110	814125110	9,66
50-32	814050032	0,75		140-90	814140090	12,08
50-40	814050040	0,75		140-110	814140110	12,08
63-32	814063032	1,18		140-125	814140125	12,08
63-40	814063040	1,18		160-90	814160090	15,70
63-50	814063050	1,18		160-110	814160110	15,70
75-50	814075050	1,93		160-125	814160125	15,70
75-63	814075063	1,93		160-140	814160140	15,70
90-50	814090050	3,32		200-110	814200110	35,02
90-63	814090063	3,32		200-125	814200125	38,64
90-75	814090075	3,32		200-140	814200140	42,50
				200-160	814200160	42,50

TE REDUCIDA

DN	CODIGO	P.V.P.		DN	CODIGO	P.V.P.
25-20	812025020	0,65		63-50	812063050	3,64
32-20	812032020	1,24		75-50	812075050	6,96
32-25	812032025	1,24		75-63	812075063	6,96
40-20	812040020	2,51		90-50	812090050	11,36
40-25	812040025	2,51		90-63	812090063	11,36
40-32	812040032	2,51		90-75	812090075	11,36
50-20	812050020	2,59		110-50	812110050	19,67
50-25	812050025	2,59		110-63	812110063	19,67
50-32	812050032	2,59		110-75	812110075	19,67
50-40	812050040	2,59		110-90	812110090	19,67

VALVULA PVC ENCOLAR

DN	CODIGO	P.V.P.
20	890100020	7,66
25	890100025	8,58
32	890100032	10,54
40	890100040	13,44
50	890100050	16,66
63	890100063	23,59
75	890100075	95,34
90	890100090	134,19



VALVULA PVC ROSCADA

ROSCA	CODIGO	P.V.P.
1/2"	890110020	7,89
3/4"	890110025	9,10
1"	890110032	11,94
1 1/4"	890110040	14,11
1 1/2"	890110050	18,06
2"	890110063	25,17
2 1/2"	890110075	96,67
3"	890110090	138,50



ACCESORIOS DE LATON ROSCADO

90 CODO H/H			92 CODO M/H		
ROSCA	CODIGO	P.V.P.	ROSCA	CODIGO	P.V.P.
3/8"	420400001	1,89	3/8"	420500001	1,82
1/2"	420400002	2,24	1/2"	420500002	2,52
3/4"	420400003	3,50	3/4"	420500003	3,85
1"	420400004	5,60	1"	420500004	6,30
1 1/4"	420400005	8,82	1 1/4"	420500005	8,82
1 1/2"	420400006	11,69	1 1/2"	420500006	12,04
2"	420400007	19,46	2"	420500007	21,70
2 1/2"	420400008	42,70	2 1/2"	420500008	44,59
3"	420400009	65,10	3"	420500009	60,20



130 TE			130R TE REDUCIDA		
ROSCA	CODIGO	P.V.P.	ROSCA	CODIGO	P.V.P.
3/8"	400400001	2,10	3/4"-1/2"	400410032	3,99
1/2"	400400002	2,66	1"-1/2"	400410042	5,18
3/4"	400400003	5,32	1"-3/4"	400410043	6,93
1"	400400004	7,42	1 1/4"-1/2"	400410052	9,03
1 1/4"	400400005	11,06	1 1/4"-3/4"	400410053	9,73
1 1/2"	400400006	14,42	1 1/4"-1"	400410054	10,08
2"	400400007	25,34	1 1/2"-1/2"	400410062	9,80
2 1/2"	400400008	54,88	1 1/2"-3/4"	400410063	10,71
3"	400400009	77,00	1 1/2"-1"	400410064	11,69
			1 1/2"-1 1/4"	400410065	13,44
			2"-1/2"	400410072	15,75
			2"-3/4"	400410073	15,75
			2"-1"	400410074	17,78
			2"-1 1/4"	400410075	19,60
			2"-1 1/2"	400410076	22,40



180 CRUZ			240 MANGUITO REDUCIDO H/H		
ROSCA	CODIGO	P.V.P.	ROSCA	CODIGO	P.V.P.
3/8"	020100001	2,59	1/2"-3/8"	070200021	1,26
1/2"	020100002	4,06	3/4"-1/2"	070200032	2,10
3/4"	020100003	5,95	1"-1/2"	070200042	2,80
1"	020100004	9,38	1"-3/4"	070200043	2,87
1 1/4"	020100005	14,28	1 1/4"-1"	070200054	4,41
1 1/2"	020100006	19,18	1 1/2"-1"	070200064	5,32
2"	020100007	33,60	1 1/2"-1 1/4"	070200065	5,81
			2"-1"	070200074	8,54
			2"-1 1/4"	070200075	8,82
			2"-1 1/2"	070200076	9,24





ACCESORIOS DE LATON ROSCADO

241 ARO REDUCIDO M/H

ROSCA	CODIGO	P.V.P.
3/8"-1/4"	040100010	0,50
1/2"-1/4"	040100020	1,05
1/2"-3/8"	040100021	0,70
3/4"-1/2"	040100032	1,26
1"-1/2"	040100042	2,45
1"-3/4"	040100043	2,03
1 1/4"- 1/2"	040100052	5,46
1 1/4"-3/4"	040100053	3,99
1 1/4"-1"	040100054	2,94
1 1/2"-1/2"	040100062	8,99
1 1/2"-3/4"	040100063	6,58
1 1/2"-1"	040100064	4,97
1 1/2"-1 1/4"	040100065	3,29
2"-1/2"	040100072	9,24
2"-3/4"	040100073	9,24
2"-1"	040100074	9,94
2"-1 1/4"	040100075	8,96
2"-1 1/2"	040100076	7,70
2 1/2"-1 1/4"	040100085	15,40
2 1/2"-1 1/2"	040100086	16,73
2 1/2"-2"	040100087	13,65
3"-2"	040100097	27,98
3"-2 1/2"	040100098	27,98
4"-2"	040100107	46,62
4"-2 1/2"	040100108	48,51
4"-3"	040100109	44,87



245 MACHON REDUCIDO

ROSCA	CODIGO	P.V.P.
3/8"-1/4"	050200010	0,84
1/2"-1/4"	050200020	1,05
1/2"-3/8"	050200021	1,05
3/4"-1/2"	050200032	1,68
1"-1/2"	050200042	2,38
1"-3/4"	050200043	2,45
1 1/4"-1/2"	050200052	5,23
1 1/4"-3/4"	050200053	3,85
1 1/4"-1"	050200054	3,92
1 1/2"-1/2"	050200062	6,70
1 1/2"-3/4"	050200063	6,16
1 1/2"-1"	050200064	5,46
1 1/2"-1 1/4"	050200065	5,53
2"-3/4"	050200073	10,23
2"-1"	050200074	7,70
2"-1 1/4"	050200075	7,84
2"-1 1/2"	050200076	8,26
2 1/2"-2"	050200087	16,66
3"-2"	050200097	23,94
3"-2 1/2"	050200098	22,40

270 MANGUITO H/H

ROSCA	CODIGO	P.V.P.
3/8"	070100001	1,26
1/2"	070100002	1,68
3/4"	070100003	2,59
1"	070100004	4,06
1 1/4"	070100005	5,60
1 1/2"	070100006	8,12
2"	070100007	14,98
2 1/2"	070100008	23,31
3"	070100009	30,31
4"	070100010	61,18



246 RACOR MARSELLA RED. M/H

ROSCA	CODIGO	P.V.P.
3/8"-1/2"	080100012	1,40
1/2"-3/8"	080100021	1,19
1/2"-3/4"	080100023	2,03
1/2"-1"	080100024	3,22
3/4"-1/2"	080100032	1,82
3/4"-1"	080100034	3,22
3/4"-1 1/4"	080100035	4,85
1"-3/4"	080100043	3,22
1"-1 1/4"	080100045	4,76
1"-1 1/2"	080100046	5,74
1"-2"	080100047	9,52
1 1/4"-1 1/2"	080100056	7,42
1 1/4"-2"	080100057	9,94
1 1/2"-2"	080100067	9,38
2"-2 1/2"	080100078	17,78



ACCESORIOS DE LATON ROSCADO

280 MACHON DOBLE			290 TAPON MACHO		
ROSCA	CODIGO	P.V.P.	ROSCA	CODIGO	P.V.P.
1/8"	050100011	0,34	1/4"	060100000	0,56
1/4"	050100000	0,53	3/8"	060100001	0,66
3/8"	050100001	0,91	1/2"	060100002	0,88
1/2"	050100002	1,26	3/4"	060100003	1,40
3/4"	050100003	1,75	1"	060100004	2,24
1"	050100004	2,80	1 1/4"	060100005	3,43
1 1/4"	050100005	4,34	1 1/2"	060100006	4,90
1 1/2"	050100006	5,88	2"	060100007	8,26
2"	050100007	9,10	2 1/2"	060100008	17,57
2 1/2"	050100008	20,44	3"	060100009	23,80
3"	050100009	31,64	4"	060100010	39,20
4"	050100010	68,74			



300 TAPON HEMBRA			315 ENTRONQUE MANGUERA		
ROSCA	CODIGO	P.V.P.	ROSCA	CODIGO	P.V.P.
3/8"	060200001	0,70	3/8"-12mm	110100112	1,26
1/2"	060200002	0,98	1/2"-14mm	110100214	1,96
3/4"	060200003	1,47	3/4"-20mm	110100320	2,80
1"	060200004	2,24	1"-25mm	110100425	4,62
1 1/4"	060200005	2,80	1"-30mm	110100430	5,04
1 1/2"	060200006	4,20	1 1/4"-35mm	110100535	9,38
2"	060200007	6,58	1 1/2"-45mm	110100645	11,90
			2"-60mm	110100760	21,00



340 NUDO ENLACE H/H			341 NUDO ENLACE M/H		
ROSCA	CODIGO	P.V.P.	ROSCA	CODIGO	P.V.P.
1/2"	480200002	5,60	1/2"	480100002	5,88
3/4"	480200003	8,26	3/4"	480100003	8,68
1"	480200004	11,20	1"	480100004	13,02
1 1/4"	480200005	17,22	1 1/4"	480100005	18,90
1 1/2"	480200006	21,70	1 1/2"	480100006	25,48
2"	480200007	36,40	2"	480100007	37,80
2 1/2"	480200008	78,40	2 1/2"	480100008	95,20
3"	480200009	103,60	3"	480100009	133,00





ACCESORIOS DE LATON ROSCADO

529 RACOR MARSELLA		
ROSCA	CODIGO	P.V.P.
3/8"	080100001	0,80
1/2"	080100002	1,22
3/4"	080100003	2,03
1"	080100004	3,29
1 1/4"	080100005	5,04
1 1/2"	080100006	6,93
2"	080100007	10,78



PITON MANGUERA		
DN	CODIGO	P.V.P.
16	090100016	9,59
20	090100020	8,01
25	090100025	13,14
30	090100030	18,56
35	090100035	47,77

MEDIO ENLACE MANGUERA		
DN	CODIGO	P.V.P.
20	100100020	2,48
25	100100025	4,03
30	100100030	6,19
35	100100035	9,58
45	100100045	17,28
60	100100060	28,44
70	100100070	41,04



MEDIO ENLACE ROSCADO		
ROSCA	CODIGO	P.V.P.
1/2"	100200002	1,94
3/4"	100200003	3,35
1"	100200004	4,54
1 1/4"	100200005	8,42
1 1/2"	100200006	14,33
2"	100200007	23,72
2 1/2"	100200008	28,08

COLLARIN CIEGO		
DN	CODIGO	P.V.P.
20	840900020	6,23
25	840900025	6,98
32	840900032	10,00
40	840900040	13,38
50	840900050	16,82
63	840900063	21,27
75	840900075	31,79
90	840900090	52,86



COLLARIN ROSCADO			
DN	ROSCA	CODIGO	P.V.P.
20	1/2"	840200020	7,35
25	1/2"	840200025	7,75
32	1/2"	840200032	9,92
32	3/4"	840300032	10,50
40	1/2"	840200040	15,61
40	3/4"	840300040	14,85
50	1/2"	840200050	15,12
50	3/4"	840300050	14,98
50	1"	840400050	15,35
63	1/2"	840200063	25,27
63	3/4"	840300063	24,74
63	1"	840400063	24,88
75	3/4"	840300075	43,18
75	1"	840400075	41,94
90	1/2"	840200090	63,67
90	3/4"	840300090	55,06
90	1"	840400090	56,94

RACOR DEPOSITO		
DN	CODIGO	P.V.P.
3/8"	030100001	2,45
1/2"	030100002	3,43
3/4"	030100003	4,62
1"	030100004	7,00
1 1/4"	030100005	9,80
1 1/2"	030100006	14,70
2"	030100007	23,10
2 1/2"	030100008	33,60
3"	030100009	59,78





ACCESORIOS DE LATON ROSCADO

ABRAZADERA TAPAPOROS			ABRAZADERA ROSCADA			
DN	CODIGO	P.V.P.	DN	ROSCA	CODIGO	P.V.P.
10	770000010	7,63	15	1/2"	770000215	17,01
12	770000012	8,54	18	1/2"	770000218	17,57
15	770000015	12,11	22	1/2"	770000222	19,18
18	770000018	14,42	28	3/4"	770000328	27,16
22	770000022	15,75	35	3/4"	770000335	34,09
28	770000028	21,28	42	1"	770000442	47,18
35	770000035	26,18	54	1 1/4"	770000554	77,84



FILTROS PARA AGUA POTABLE

FILTRO 3 PIEZAS			SILIFOSFATO		
DN	CODIGO	P.V.P.	DN	CODIGO	P.V.P.
3/4"	580000241	22,02	1"	580000232	28,49
1"	580000221	25,90			



POLIPROPILENO BOBINADO			LLAVE	
DN	CODIGO	P.V.P.	CODIGO	P.V.P.
3/4"	580000243	6,13	580000223	4,40
1"	580000239	7,35		



CARBON ACTIVO			SOPORTE	
DN	CODIGO	P.V.P.	CODIGO	P.V.P.
1"	580000238	9,30	580000240	6,15





ACCESORIOS DE LATON PARA TUBO POLIETILENO ROSCA INTERIOR

RACOR RECTO MACHO			RACOR RECTO HEMBRA			
ROSCA	CODIGO	P.V.P.		ROSCA	CODIGO	P.V.P.
1/2"	370110020	3,68		1/2"	370210020	3,82
3/4"	370110025	4,73		3/4"	370210025	4,76
1"	370110032	7,00		1"	370210032	7,35
1 1/4"	370110040	12,01		1 1/4"	370210040	12,22
1 1/2"	370110050	16,24		1 1/2"	370210050	17,22
2"	370110063	29,82		2"	370210063	31,54

RACOR RECTO DOBLE			RACOR CODO DOBLE			
ROSCA	CODIGO	P.V.P.		ROSCA	CODIGO	P.V.P.
1/2"	460100020	6,72		1/2"	420110020	6,72
3/4"	460100025	7,60		3/4"	420110025	10,19
1"	460100032	11,45		1"	420110032	13,72
1 1/4"	460100040	19,64		1 1/4"	420110040	24,26
1 1/2"	460100050	28,67		1 1/2"	420110050	35,98
2"	460100063	49,46		2"	420110063	54,22

RACOR CODO MACHO			RACOR CODO HEMBRA			
ROSCA	CODIGO	P.V.P.		ROSCA	CODIGO	P.V.P.
1/2"	420210020	4,48		1/2"	420310020	4,97
3/4"	420210025	6,51		3/4"	420310025	6,09
1"	420210032	10,08		1"	420310032	10,71
1 1/4"	420210040	17,50		1 1/4"	420310040	17,50
1 1/2"	420210050	24,40		1 1/2"	420310050	24,22
2"	420210063	42,07		2"	420310063	46,87

RACOR EN T			RACOR EN T HEMBRA			
ROSCA	CODIGO	P.V.P.		ROSCA	CODIGO	P.V.P.
1/2"	400110020	10,19		1/2"	400310020	8,12
3/4"	400110025	12,71		3/4"	400310025	10,99
1"	400110032	19,74		1"	400310032	16,91
1 1/4"	400110040	31,22		1 1/4"	400310040	27,83
1 1/2"	400110050	47,74		1 1/2"	400310050	36,65
2"	400110063	85,79		2"	400310063	69,16

RACOR EN T MACHO		
ROSCA	CODIGO	P.V.P.
1/2"	400210020	7,60
3/4"	400210025	10,19
1"	400210032	16,24
1 1/4"	400210040	26,74
1 1/2"	400210050	36,47
2"	400210063	62,16



ACCESORIOS DE HIERRO GALVANIZADO ROSCADO

90 CODO H/H			92 CODO M/H		
ROSCA	CODIGO	P.V.P.	ROSCA	CODIGO	P.V.P.
3/8"	420450001	1,32	3/8"	420550001	1,37
1/2"	420450002	0,81	1/2"	420550002	0,98
3/4"	420450003	1,12	3/4"	420550003	1,23
1"	420450004	1,72	1"	420550004	2,12
1 1/4"	420450005	3,19	1 1/4"	420550005	3,93
1 1/2"	420450006	3,99	1 1/2"	420550006	5,41
2"	420450007	6,40	2"	420550007	7,82
2 1/2"	420450008	21,92	2 1/2"	420550008	24,85
3"	420450009	33,59	3"	420550009	38,04
4"	420450010	53,01	4"	420550010	50,98



130 TE			130R TE REDUCIDA		
ROSCA	CODIGO	P.V.P.	ROSCA	CODIGO	P.V.P.
1/4"	400450000	2,27	3/4"-1/2"	400460032	1,80
3/8"	400450001	1,84	1"-1/2"	400460042	2,55
1/2"	400450002	1,13	1"-3/4"	400460043	2,84
3/4"	400450003	1,67	1 1/4"-1/2"	400460052	4,96
1"	400450004	2,50	1 1/4"-3/4"	400460053	5,48
1 1/4"	400450005	4,73	1 1/4"-1"	400460054	5,76
1 1/2"	400450006	6,14	1 1/2"-1/2"	400460062	6,80
2"	400450007	9,21	1 1/2"-3/4"	400460063	7,04
2 1/2"	400450008	31,75	1 1/2"-1"	400460064	7,09
3"	400450009	37,99	1 1/2"-1 1/4"	400460065	10,58
4"	400450010	67,05	2"-1/2"	400460072	9,36
			2"-3/4"	400460073	12,99
			2"-1"	400460074	9,92
			2"-1 1/4"	400460075	12,95
			2"-1 1/2"	400460076	14,88



180 CRUZ			240 MANGUITO REDUCIDO H/H		
ROSCA	CODIGO	P.V.P.	ROSCA	CODIGO	P.V.P.
1/2"	020500002	3,97	1/2"-3/8"	070600021	1,37
3/4"	020500003	5,95	3/4"-1/2"	070600032	1,56
1"	020500004	7,04	1"-1/2"	070600042	2,08
1 1/4"	020500005	9,92	1"-3/4"	070600043	1,94
1 1/2"	020500006	13,32	1 1/4"-1"	070600054	3,69
2"	020500007	20,74	1 1/2"-1"	070600064	4,21
2 1/2"	020500008	50,32	1 1/2"-1 1/4"	070600065	4,35
			2"-1"	070600074	8,65
			2"-1 1/4"	070600075	7,80
			2"-1 1/2"	070600076	6,76





ACCESORIOS DE HIERRO GALVANIZADO ROSCADO

241 ARO REDUCIDO M/H		
ROSCA	CODIGO	P.V.P.
1/2"-1/4"	040500020	0,85
1/2"-3/8"	040500021	0,85
3/4"-3/8"	040500031	1,04
3/4"-1/2"	040500032	0,74
1"-1/2"	040500042	1,32
1"-3/4"	040500043	1,32
1 1/4"- 1/2"	040500052	2,27
1 1/4"-3/4"	040500053	2,17
1 1/4"-1"	040500054	1,87
1 1/2"-1/2"	040500062	2,88
1 1/2"-3/4"	040500063	3,07
1 1/2"-1"	040500064	2,41
1 1/2"-1 1/4"	040500065	2,41
2"-1/2"	040500072	6,14
2"-3/4"	040500073	6,00
2"-1"	040500074	4,63
2"-1 1/4"	040500075	4,39
2"-1 1/2"	040500076	4,16
2 1/2"-1"	040500084	13,18
2 1/2"-1 1/4"	040500085	13,18
2 1/2"-1 1/2"	040500086	12,95
2 1/2"-2"	040500087	12,14
3"-1"	040500094	14,32
3"-1 1/4"	040500095	15,03
3"-1 1/2"	040500096	14,22
3"-2"	040500097	15,26
3"-2 1/2"	040500098	15,31
4"-2"	040500107	26,74
4"-2 1/2"	040500108	26,98
4"-3"	040500109	26,98



245 MACHON REDUCIDO		
ROSCA	CODIGO	P.V.P.
1/2"-3/8"	050600021	1,84
3/4"-1/2"	050600032	1,46
1"-1/2"	050600042	3,35
1"-3/4"	050600043	1,89
1 1/4"-1"	050600054	3,21
1 1/2"-1"	050600064	6,71
1 1/2"-1 1/4"	050600065	5,06
2"-1 1/4"	050600075	8,84
2"-1 1/2"	050600076	7,99
2 1/2"-2"	050600087	17,25
3"-2 1/2"	050600098	27,36

246 RACOR MARSELLA RED. H/M		
ROSCA	CODIGO	P.V.P.
3/4"-1/2"	080500032	1,94
1"-1/2"	080500042	2,65
1"-3/4"	080500043	2,69
1 1/4"-1"	080500054	5,06
1 1/2"-1"	080500064	6,85
1 1/2"-1 1/4"	080500065	8,27
2"-1 1/4"	080500075	8,74
2"-1 1/2"	080500076	9,64

270 MANGUITO H/H		
ROSCA	CODIGO	P.V.P.
1/4"	070500000	1,28
3/8"	070500001	1,18
1/2"	070500002	0,81
3/4"	070500003	0,98
1"	070500004	1,29
1 1/4"	070500005	2,32
1 1/2"	070500006	3,17
2"	070500007	5,01
2 1/2"	070500008	17,39
3"	070500009	22,96
4"	070500010	46,68



ACCESORIOS DE HIERRO GALVANIZADO ROSCADO

280 MACHON DOBLE			290 TAPON MACHO			
ROSCA	CODIGO	P.V.P.		ROSCA	CODIGO	P.V.P.
3/8"	050500001	1,51		3/8"	060150001	0,84
1/2"	050500002	0,81		1/2"	060150002	0,60
3/4"	050500003	0,94		3/4"	060150003	0,81
1"	050500004	1,32		1"	060150004	1,09
1 1/4"	050500005	2,46		1 1/4"	060150005	2,08
1 1/2"	050500006	3,17		1 1/2"	060150006	2,79
2"	050500007	5,01		2"	060150007	4,30
2 1/2"	050500008	15,17		2 1/2"	060150008	10,06
3"	050500009	23,58		3"	060150009	12,80
4"	050500010	43,94		4"	060150010	21,12

300 TAPON HEMBRA			340 NUDO ENLACE H/H			
ROSCA	CODIGO	P.V.P.		ROSCA	CODIGO	P.V.P.
1/2"	060250002	0,98		1/2"	480250002	4,82
3/4"	060250003	1,29		3/4"	480250003	5,95
1"	060250004	1,58		1"	480250004	7,13
1 1/4"	060250005	2,93		1 1/4"	480250005	10,25
1 1/2"	060250006	3,40		1 1/2"	480250006	13,09
2"	060250007	5,58		2"	480250007	18,76
2 1/2"	060250008	12,80		2 1/2"	480250008	43,52
3"	060250009	14,36		3"	480250009	64,07
4"	060250010	24,00				

341 NUDO ENLACE M/H			529 RACOR MARSELLA			
ROSCA	CODIGO	P.V.P.		ROSCA	CODIGO	P.V.P.
1/2"	480150002	5,39		1/2"	080500002	1,72
3/4"	480150003	6,99		3/4"	080500003	2,55
1"	480150004	8,55		1"	080500004	4,30
1 1/4"	480150005	11,48				
1 1/2"	480150006	15,59				
2"	480150007	22,30				
2 1/2"	480150008	55,42				
3"	480150009	91,00				



ACCESORIOS DE HIERRO GALVANIZADO

RACOR RECTO MACHO			RACOR RECTO HEMBRA		
ROSCA	CODIGO	P.V.P.	ROSCA	CODIGO	P.V.P.
1/2"	770110020	12,46	1/2"	770210020	12,53
3/4"	770110025	13,79	3/4"	770210025	14,14
1"	770110032	15,75	1"	770210032	15,96
1 1/4"	770110040	22,68	1 1/4"	770210040	23,31
1 1/2"	770110050	28,07	1 1/2"	770210050	28,70
2"	770110063	39,83	2"	770210063	40,95
2 1/2"	770110075	72,66	2 1/2"	770210075	74,20
3"	770110090	102,34	3"	770210090	107,10



RACOR RECTO DOBLE			RACOR CODO DOBLE		
ROSCA	CODIGO	P.V.P.	ROSCA	CODIGO	P.V.P.
1/2"	770600020	17,57	1/2"	779000020	26,88
3/4"	770600025	20,58	3/4"	779000025	29,68
1"	770600032	24,43	1"	779000032	34,30
1 1/4"	770600040	31,78	1 1/4"	779000040	44,94
1 1/2"	770600050	41,93	1 1/2"	779000050	59,99
2"	770600063	59,99	2"	779000063	94,36
2 1/2"	770600075	113,54	2 1/2"	779000075	124,39
3"	770600090	145,67	3"	779000090	157,50





ABRAZADERA TAPAPOROS CORTA			ABRAZADERA TAPAPOROS LARGA		
ROSCA	CODIGO	P.V.P.	ROSCA	CODIGO	P.V.P.
1/2"	770002002	7,56	1/2"	770002020	17,08
3/4"	770002003	8,33	3/4"	770002025	18,55
1"	770002004	11,13	1"	770002032	21,91
1 1/4"	770002005	14,28	1 1/4"	770002040	27,51
1 1/2"	770002006	17,36	1 1/2"	770002050	30,24
2"	770002007	21,91	2"	770002063	36,68
			2 1/2"	770002075	47,11
			3"	770002090	51,52







NIPPLES						
	ROSCA	CODIGO				
			150MM	200MM	300MM	500MM
 ** 15 (150mm) ** 20 (200mm) ** 30 (300mm) ** 50 (500mm)	1/2"	5201020*	1,97	2,34	3,65	5,43
	3/4"	5201030*	2,53	2,90	4,49	6,83
	1"	5201040*	3,28	4,02	6,27	9,45
	1 1/4"	5201050*	3,93	4,96	7,21	10,86
	1 1/2"	5201060*	4,59	5,62	8,42	12,82
	2"	5201070*	5,90	7,58	11,42	17,41
	2 1/2"	5201080*	9,55	11,23	14,32	21,53
	3"	5201090*	11,61	14,04	21,53	51,48
	4"	5201100*	18,91	22,46	29,20	71,70



ACCESORIOS INOXIDABLES ROSCADOS AISI316



90 CODO H/H			92 CODO M/H				
ROSCA	CODIGO	P.V.P.			ROSCA	CODIGO	P.V.P.
1/2"	420460002	2,80			1/2"	420560002	3,68
3/4"	420460003	4,55			3/4"	420560003	4,90
1"	420460004	7,88			1"	420560004	7,88



130 TE			270 MANGUITO H/H				
ROSCA	CODIGO	P.V.P.			ROSCA	CODIGO	P.V.P.
1/2"	400470002	4,20			1/2"	070800002	3,50
3/4"	400470003	5,95			3/4"	070800003	4,90
1"	400470004	11,20			1"	070800004	6,30



245 MACHON REDUCIDO			241 ARO REDUCIDO M/H				
ROSCA	CODIGO	P.V.P.			ROSCA	CODIGO	P.V.P.
1/2"-1/4"	050750020	4,38			1/2"-3/8"	040600021	2,28
1/2"-3/8"	050750021	4,20			3/4"-1/2"	040600032	3,33
3/4"-1/2"	050750032	5,08			1"-1/2"	040600042	4,20
1"-3/4"	050750043	7,18			1"-3/4"	040600043	4,38



ACCESORIOS INOXIDABLES ROSCADOS AISI316

280 MACHON DOBLE			290 TAPON MACHO				
ROSCA	CODIGO	P.V.P.			ROSCA	CODIGO	P.V.P.
1/2"	050700002	2,98			1/2"	060160002	1,93
3/4"	050700003	4,20			3/4"	060160003	2,98
1"	050700004	5,43			1"	060160004	4,55

315 ENTRONQUE MANGUERA			340 NUDO ENLACE H/H				
ROSCA	CODIGO	P.V.P.			ROSCA	CODIGO	P.V.P.
1/2"x15mm	110400215	4,38			1/2"	480270002	9,80
3/4"x20mm	110400320	7,00			3/4"	480270003	12,08
1"x27mm	110400427	9,45			1"	480270004	18,03

341 NUDO ENLACE M/H			NIPPLE ROSCADO POR UN EXTREMO				
ROSCA	CODIGO	P.V.P.			ROSCA	CODIGO	P.V.P.
1/2"	480170002	11,90			1/2"x35mm	520002003-I	2,45
3/4"	480170003	14,18			3/4"x40mm	520003004-I	3,33
1"	480170004	21,53			1"x40mm	520004004-I	4,73



ACCESORIOS ELECTROSOLDABLES PARA PE

CODO 45°			CODO 90°		
DN	CODIGO	P.V.P.	DN	CODIGO	P.V.P.
32	634500032	12,22	20	639000020	12,80
40	634500040	14,89	25	639000025	11,37
50	634500050	18,92	32	639000032	11,37
63	634500063	21,68	40	639000040	14,64
75	634500075	31,20	50	639000050	18,80
90	634500090	37,76	63	639000063	21,19
110	634500110	56,88	75	639000075	30,52
125	634500125	77,82	90	639000090	36,31
140	634500140	106,18	110	639000110	52,40
160	634500160	127,03	125	639000125	72,63
180	634500180	168,16	140	639000140	106,18
200	634500200	364,58	160	639000160	127,03
225	634500225	431,60	180	639000180	168,16
250	634500250	566,25	200	639000200	364,58
			225	639000225	431,60
			250	639000250	566,25



MANGUITO			REDUCCION		
DN	CODIGO	P.V.P.	DN	CODIGO	P.V.P.
20	630300020	4,34	20-16	633020016	9,21
25	630300025	4,44	25-20	633025020	8,50
32	630300032	4,60	32-20	633032020	8,50
40	630300040	4,89	32-25	633032025	8,50
50	630300050	6,50	40-25	633040025	15,86
63	630300063	7,16	40-32	633040032	13,78
75	630300075	12,42	50-25	633050025	17,39
90	630300090	14,51	50-32	633050032	15,64
110	630300110	17,05	50-40	633050040	15,64
125	630300125	28,13	63-32	633063032	17,39
140	630300140	42,50	63-40	633063040	17,34
160	630300160	32,20	63-50	633063050	17,34
180	630300180	50,45	75-63	633075063	24,71
200	630300200	57,22	90-50	633090050	27,63
225	630300225	105,24	90-63	633090063	25,03
250	630300250	106,23	90-75	633090075	32,95
280	630300280	250,96	110-63	633110063	35,02
315	630300315	212,93	110-90	633110090	36,15
355	630300355	417,56	125-90	633125090	59,75
400	630300400	538,78	125-110	633125110	63,45
			160-90	633160090	98,86
			160-110	633160110	98,86
			160-125	633160125	115,21
			180-125	633180125	160,33





ACCESORIOS ELECTROSOLDABLES PARA PE

TE			TE REDUCIDA		
DN	CODIGO	P.V.P.	DN	CODIGO	P.V.P.
20	630200020	14,85	025/020	632025020	23,03
25	630200025	15,30	032/020	632032020	32,45
32	630200032	15,30	032/025	632032025	28,75
40	630200040	17,86	040/020	632040020	34,36
50	630200050	18,92	050/020	632050020	63,36
63	630200063	22,10	050/032	632050032	52,27
75	630200075	35,17	063/020	632063020	60,89
90	630200090	36,31	063/032	632063032	58,62
110	630200110	61,64	063/040	632063040	62,72
125	630200125	79,33	063/050	632063050	93,34
160	630200160	136,39	075/063	632075063	69,27
180	630200180	189,24	090/063	632090063	109,59
200	630200200	440,39	110/063	632110063	119,94
225	630200225	521,28	110/090	632110090	118,89
250	630200250	664,67	125/090	632125090	173,94
			125/110	632125110	170,36
			160/090	632160090	240,25
			160/110	632160110	238,34
			160/125	632160125	265,63
			180/090	632180090	348,84
			180/110	632180110	389,13
			180/125	632180125	467,26
			180/140	632180140	348,84
			180/160	632180160	348,84
			200/090	632200090	665,02
			200/110	632200110	665,02
			225/090	632225090	755,84
			225/110	632225110	755,84
			250/090	632250090	950,50
			250/110	632250110	950,50



TRANSICION MACHO			TRANSICION HEMBRA		
DN	CODIGO	P.V.P.	DN	CODIGO	P.V.P.
1/2" - 20	721300220	17,92	1/2" - 20	721400220	17,92
3/4" - 25	721300325	21,14	3/4" - 25	721400325	20,76
1" - 32	721300432	23,91	1" - 32	721400432	22,02
1 1/4" - 40	721300540	38,78	1 1/4" - 40	721400540	34,20
1 1/2" - 50	721300650	42,56	1 1/2" - 50	721400650	41,55
2" - 63	721300763	52,19	2" - 63	721400763	56,98
2 1/2" - 75	721300875	95,55	2 1/2" - 75	721400875	100,84
3" - 90	721300990	149,42	3" - 90	721400990	123,83
4" - 110	721301010	197,40	4" - 110	721401010	173,64
4" - 125	721301012	203,53	4" - 125	721401012	181,58





ACCESORIOS SOLDADURA TOPE PARA PE

CODO 45° SDR11			CODO 90° SDR11		
DN	CODIGO	P.V.P.	DN	CODIGO	P.V.P.
20	724500020	3,65	20	729000020	3,59
25	724500025	3,93	25	729000025	4,01
32	724500032	4,53	32	729000032	4,47
40	724500040	5,16	40	729000040	5,05
50	724500050	6,24	50	729000050	6,75
63	724500063	10,41	63	729000063	10,49
75	724500075	13,12	75	729000075	14,35
90	724500090	17,13	90	729000090	17,32
110	724500110	24,07	110	729000110	28,86
125	724500125	48,81	125	729000125	48,92
140	724500140	58,70	140	729000140	58,70
160	724500160	60,62	160	729000160	58,70
180	724500180	81,28	180	729000180	77,83
200	724500200	97,91	200	729000200	113,09
225	724500225	131,51	225	729000225	124,95
250	724500250	239,36	250	729000250	239,36
280	724500280	361,74	280	729000280	384,89
315	724500315	379,82	315	729000315	406,01





VALONA SDR11			TE SDR11		
DN	CODIGO	P.V.P.	DN	CODIGO	P.V.P.
20	720100020	3,50	20	720200020	4,17
25	720100025	3,68	25	720200025	4,64
32	720100032	4,32	32	720200032	5,52
40	720100040	5,11	40	720200040	6,75
50	720100050	5,83	50	720200050	9,60
63	720100063	7,10	63	720200063	10,97
75	720100075	8,69	75	720200075	18,42
90	720100090	11,41	90	720200090	25,74
110	720100110	14,11	110	720200110	27,81
125	720100125	17,25	125	720200125	57,83
140	720100140	22,08	140	720200140	80,30
160	720100160	29,83	160	720200160	92,09
180	720100180	42,05	180	720200180	148,19
200	720100200	43,31	200	720200200	173,57
225	720100225	52,89	225	720200225	273,19
250	720100250	69,56	250	720200250	331,97
280	720100280	125,04	280	720200280	519,14
315	720100315	143,69	315	720200315	528,35





ACCESORIOS SOLDADURA TOPE PARA PE

REDUCCION SDR11						
DN	CODIGO	P.V.P.		DN	CODIGO	P.V.P.
25-20	723025020	2,80		250-160	723250160	158,76
32-20	723032020	3,11		250-180	723250180	144,32
32-25	723032025	3,11		250-200	723250200	144,32
40-25	723040025	4,42		250-225	723250225	144,32
40-32	723040032	4,42		280-200	723280200	211,34
50-25	723050025	5,61		280-225	723280225	211,34
50-32	723050032	5,61		280-250	723280250	241,80
50-40	723050040	5,61		315-200	723315200	278,51
63-32	723063032	7,44		315-225	723315225	278,51
63-40	723063040	7,44		315-250	723315250	242,43
63-50	723063050	7,44		315-280	723315280	278,51
75-50	723075050	11,01		355-250	723355250	985,21
75-63	723075063	11,01		355-280	723355280	985,21
90-50	723090050	12,27		355-315	723355315	632,99
90-63	723090063	14,78		400-280	723400280	873,14
90-75	723090075	14,78		400-315	723400315	873,14
110-63	723110063	19,69		400-355	723400355	873,14
110-75	723110075	23,90				
110-90	723110090	24,01				
125-63	723125063	24,70				
125-90	723125090	22,82				
125-110	723125110	22,82				
140-90	723140090	49,64				
140-110	723140110	51,24				
140-125	723140125	37,73				
160-90	723160090	45,15				
160-110	723160110	45,15				
160-125	723160125	51,13				
160-140	723160140	51,80				
180-90	723180090	71,64				
180-110	723180110	86,15				
180-125	723180125	64,04				
180-160	723180160	64,04				
200-140	723200140	76,62				
200-160	723200160	67,78				
200-180	723200180	82,01				
225-140	723225140	112,88				
225-160	723225160	124,17				
225-180	723225180	124,17				
225-200	723225200	139,57				

TAPON SDR11		
DN	CODIGO	P.V.P.
20	720010020	3,02
25	720010025	3,36
32	720010032	4,21
40	720010040	5,27
50	720010050	6,22
63	720010063	8,29
75	720010075	10,88
90	720010090	16,07
110	720010110	19,05
125	720010125	25,87
140	720010140	35,24
160	720010160	35,24
180	720010180	49,08
200	720010200	64,07
225	720010225	79,09
250	720010250	113,35
280	720010280	187,65
315	720010315	201,05
355	720010355	371,91
400	720010400	726,48



COLLARINES DE P.P.F.V. REFORZADOS (*)

PARA TUBO DE PE							
DN	ROSCA	CODIGO	P.V.P.	DN	ROSCA	CODIGO	P.V.P.
20	1/2"	235200020	1,96	125	1 1/4"	235500125	14,80
20	3/4"	235300020	1,96	125	1 1/2"	235600125	14,80
25	1/2"	235200025	1,96	125	2"	235700125	14,80
25	3/4"	235300025	1,96	125	2 1/2"	235800125	14,80
32	1/2"	235200032	2,53	140	1/2"	235200140	22,40
32	3/4"	235300032	2,53	140	3/4"	235300140	22,40
32	1"	235400032	2,53	140	1"	235400140	22,40
40	1/2"	235200040	3,14	140	1 1/4"	235500140	22,40
40	3/4"	235300040	3,14	140	1 1/2"	235600140	22,40
40	1"	235400040	3,14	140	2"	235700140	22,40
50	1/2"	235200050	3,19	140	2 1/2"	235800140	22,40
50	3/4"	235300050	3,19	140	3"	235900140	22,40
50	1"	235400050	3,19	160	1/2"	235200160	24,80
50	1 1/4"	235500050	4,99	160	3/4"	235300160	24,80
63	1/2"	235200063	4,99	160	1"	235400160	24,80
63	3/4"	235300063	4,99	160	1 1/4"	235500160	24,80
63	1"	235400063	4,99	160	1 1/2"	235600160	24,80
63	1 1/4"	235500063	4,99	160	2"	235700160	24,80
63	1 1/2"	235600063	4,99	160	2 1/2"	235800160	24,80
75	1/2"	235200075	7,25	160	3"	235900160	24,80
75	3/4"	235300075	7,25	180	1"	235400180	47,68
75	1"	235400075	7,25	180	1 1/4"	235500180	47,68
75	1 1/4"	235500075	7,25	180	1 1/2"	235600180	47,68
75	1 1/2"	235600075	7,25	180	2"	235700180	47,68
75	2"	235700075	7,25	180	2 1/2"	235800180	47,68
90	1/2"	235200090	7,70	180	3"	235900180	47,68
90	3/4"	235300090	7,70	200	1 1/4"	235500200	87,72
90	1"	235400090	7,70	200	1 1/2"	235600200	87,72
90	1 1/4"	235500090	7,70	200	2"	235700200	87,72
90	1 1/2"	235600090	7,70	200	2 1/2"	235800200	87,72
90	2"	235700090	7,70	200	3"	235900200	87,72
110	1/2"	235200110	10,06	200	4"	235000200	87,72
110	3/4"	235300110	10,06				
110	1"	235400110	10,06				
110	1 1/4"	235500110	10,06				
110	1 1/2"	235600110	10,06				
110	2"	235700110	10,06				
110	2 1/2"	235800110	10,06				
125	1/2"	235200125	14,80				
125	3/4"	235300125	14,80				
125	1"	235400125	14,80				



* SE SUMINISTRA EN CAJAS COMPLETAS



COLLARINES DE FUNDICION

PARA TUBO DE FBC



DN	ROSCA	CODIGO	P.V.P.
50	1/2"	250200050	11,12
50	3/4"	250300050	11,12
50	1"	250400050	11,12
60	1/2"	250200060	17,19
60	3/4"	250300060	17,19
60	1"	250400060	17,19
60	1 1/4"	250500060	17,19
70	1/2"	250200070	18,49
70	3/4"	250300070	18,49
70	1"	250400070	18,49
70	1 1/4"	250500070	18,49
80	1/2"	250200080	20,48
80	3/4"	250300080	20,48
80	1"	250400080	20,48
80	1 1/4"	250500080	20,48
100	3/4"	250300100	23,58
100	1"	250400100	23,58
100	1 1/4"	250500100	23,58
125	3/4"	250300125	27,87
125	1"	250400125	27,87
125	1 1/4"	250500125	27,87
150	3/4"	250300150	30,54
150	1"	250400150	30,54
150	1 1/4"	250500150	30,54
150	1 1/2"	250600150	30,54
200	1 1/2"	250600200	43,35
200	2"	250700200	43,35
250	1 1/2"	250600250	59,88
250	2"	250700250	59,88
300	1 1/2"	250600300	63,62
300	2"	250700300	63,62

UNIONES GIBALT PARA TUBO DE FIBROCEMENTO

UNION GIBALT DE FUNDICION PARA FBC

DN	CODIGO	P.V.P.
50-AF	300100050	19,63
60-AF	300100060	23,89
70-AF	300100070	28,25
80-AD	300200080	33,23
80-EF	301000080	35,31
100-AC	300300100	37,59
100-EF	301000100	43,62
125-AC	300300125	46,94
125-D	300900125	54,00
125-EF	301000125	74,77
150-AB	300400150	58,16
150-C	300800150	62,31
150-D	300900150	83,08
150-EF	301000150	83,08
200-AB	300400200	85,47
200-C	300800200	116,31
200-D	300900200	144,97
250-A	300500250	112,16
250-B	300600250	127,53
250-C	300800250	165,54
250-D	300900250	218,09
300-A	300500300	168,03
300-B	300600300	174,47
300-C	300800300	175,51
300-D	300900300	230,24
350-A	300500350	197,32
350-B	300600350	207,70
350-C	300800350	218,09
350-D	300900350	228,47
400-C	300800400	238,86



UNION GIBALT CIEGAS PARA FBC

DN	CODIGO	P.V.P.
50-AF	310100050	55,13
60-AF	310100060	63,00
70-AF	310100070	70,88
80-AD	310200080	78,75
80-EF	311000080	91,88
100-AD	310200100	99,75
100-EF	311000100	118,13
125-AC	310300125	136,50
125-D	310900125	157,50
125-EF	311000125	168,00
150-AC	310300150	189,00



GOMA PARA UNION GIBALT FBC

DN	CODIGO	P.V.P.
50	470200050	0,50
60	470200060	0,77
70	470200070	1,18
80	470200080	1,35
100	470200100	1,61
125	470200125	2,09
150	470200150	2,91
200	470200200	3,80
250	470200250	4,64
300	470200300	5,79
350	470200350	9,70



HIDRANTES



BAJO NIVEL DE TIERRA			
DESCRIPCIÓN	CODIGO	P.V.P.	
DN080-3" C/Arqueta - 1 boca 2 1/2"	640100080	619,18	
DN080-3" S/Arqueta - 1 boca 2 1/2"	640100082	438,02	
DN100-4" C/Arqueta - 1 boca 2 1/2"	640100100	633,02	
DN100-4" C/Arqueta - 2 bocas 2 1/2"	640100102	832,81	
DN100-4" C/Arqueta - 1 boca 4"(BOMBERO)	640100105	748,41	
DN100-4" S/Arqueta - 1 boca 2 1/2"	640100110	451,90	
DN100-4" S/Arqueta - 2 bocas 2 1/2"	640100112	623,97	
DN100-4" S/Arqueta - 1 boca 4"(BOMBERO)	640100115	539,78	
Arqueta para Hidrante de 1 Boca	640000010	226,45	
Arqueta para Hidrante de 2 Bocas	640000020	262,10	
Llave Acc. 25x25 para hidrante bajo nivel de tierra	640000001	71,41	
Llave para apertura Arqueta	640000002	18,77	



COLUMNA SECA TIFON PLUS			
DESCRIPCIÓN	CODIGO	P.V.P.	
DN080-3" 2 bocas 1 1/2" + 1 boca 2 1/2" RECTO	640200080	1197,05	
DN080-3" 2 bocas 1 1/2" + 1 boca 2 1/2" CURVO	640200085	1318,48	
DN100-4" 2 bocas 2 1/2" y una boca 4" RECTO	640200100	1203,93	
DN100-4" 2 bocas 2 1/2" y una boca 4" CURVO	640200105	1324,32	
DN150-6" 2 bocas 2 1/2" y una boca 4" RECTO	640200150	1522,62	
DN150-6" 2 bocas 2 1/2" y una boca 4" CURVO	640200155	1831,35	
Fanal de proteccion hidrante columna seca	640000030	479,04	
Llave Acc. 30x30 para hidrante columna seca	640000007	64,92	
Llave Accionamiento para Fanal	640000035	10,63	



CAMARA DE DESCARGA AUTOMATICA



CAMARA DE DESCARGA			
DESCRIPCIÓN	CODIGO	P.V.P.	
Automática de fundicion 600L	440100000	612,50	



JUEGOS DE REGISTRO FUNDICION GRIS

CIRCULAR ACERA			CIRCULAR CALZADA		
DN	CODIGO	P.V.P.	DN	CODIGO	P.V.P.
300	330100300	29,69	400	330200400	86,10
400	330100400	49,83	500	330200500	117,87
500	330100500	95,19	600	330200600	185,56
600	330100600	118,73	700	330200700	278,31
700	330100700	222,64	800	330200800	397,05



CUADRADO ACERA			CUADRADO CALZADA		
DN	CODIGO	P.V.P.	DN	CODIGO	P.V.P.
25x25	330102525	24,74	40x40	330204040	90,70
30x30	330103030	29,69	50x50	330205050	131,52
40x40	330104040	54,43	60x60	330206060	259,77
50x50	330105050	99,81	70x70	330207070	333,98
60x60	330106060	166,97	80x80	330208080	452,70
100x100	330101000	649,43	100x100	330201000	779,31



JUEGOS DE REJILLA

FUNDICION GRIS RECTA			FUNDICION GRIS CONCAVA		
DN	CODIGO	P.V.P.	DN	CODIGO	P.V.P.
12x50	340101250	40,85	26x40	340202640	87,57
14x54	340101454	68,02	28x38	340202838	72,53
25x45	340102545	81,61	35x40	340203540	123,69
30x50	340103050	90,70	30x85	340203085	288,62
40x70	340104070	178,14			

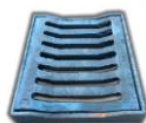

FUNDICION GRIS CON TAPA			FUNDICION GRIS CIRCULAR		
DN	CODIGO	P.V.P.	DN	CODIGO	P.V.P.
30x80	340303040	156,70	600	340400600	173,18



FUNDICION NODULAR C-250			CANALETA FUNDICION NODULAR D-400		
DN	CODIGO	P.V.P.	DN	CODIGO	P.V.P.
37x57	340403757	69,65	15x1000/12	340501510	114,00
40x40	340404040	81,20	20x1000/15	340502010	171,00
50x50	340405050	140,00	30x625/18	340503062	179,55
40x60	330404060	148,61			





JUEGOS DE REGISTRO FUNDICION NODULAR

FUNDICION NODULAR CUADRADO					
DN	CODIGO	B-125	C-250	D-400	E-600
20x20	3304*2020	16,63			
30x30	3304*3030	22,61	48,82		
40x40	3304*4040	39,42	70,92	83,63	178,99
50x50	3304*5050	71,24	114,37	143,96	240,01
60x60	3304*6060	100,40	164,59	196,45	341,71
70x70	3304*7070	178,52	231,55	303,91	709,20
80x80	3304*8080	212,36	306,86	359,96	853,20
90x90	3304*9090	305,96	421,20	547,20	
100x100	3304*1000	554,40	604,80	705,60	



- * 0 (B-125)
- * 1 (C-250)
- * 2 (D-400)
- * 3 (E-600)

FUNDICION NODULAR CUADRADO B-125

DN	CODIGO	P.V.P.
15x15	330501515	11,96
20x20	330502020	14,60
25x25	330502525	22,52



FUNDICION NODULAR CIRCULAR

DN	CODIGO	DESCRIPCION	P.V.P.
600/40	330400600	600/40 C-250 SIN CIERRE	119,77
600/70	330400607	600/60 D-400 700MM ABAT.DESM.	160,34
600/100	330400610	600/100 D-400 750MM ABAT.DESM.	241,50
650/100	330400650	640/100 D-400 815MM ABAT.DESM.	255,50



TRAMPILLONES

TRAMPILLONES		
DN	CODIGO	P.V.P.
125x125/90	690100001	41,17
165	690100003	39,16
310	690100005	87,07





ACCESORIO DE FUNDICION CON BRIDA PARA TUBERIA DE FUNDICION



DN	CODIGO	CODO			
		11°	22°	45°	90°
40	62**00040				37,01
50	62**00050			50,88	50,88
65	62**00065	56,42	56,42	56,42	56,42
80	62**00080	65,38	65,38	65,39	65,38
100	62**00100	78,76	78,76	78,76	83,12
125	62**00125	98,19	98,19	98,19	98,19
150	62**00150	124,17	124,17	124,17	126,08
200	62**00200	204,44	204,44	204,43	224,88
250	62**00250	422,52	422,52	422,53	422,53
300	62**00300	499,73	506,33	506,32	591,20
350	62**00350	603,63	609,30	670,43	891,42
400	62**00400	776,08	785,29	822,57	1057,65
450	62**00450	990,80	994,73	980,93	1258,04
500	62**00500	1273,13	1284,36	1309,51	1548,59
600	62**00600	1843,96	1877,81	1952,24	2385,26
700	62**00700	3590,21	3868,22	3898,80	4959,01
800	62**00800	4861,74	5246,41	5278,08	6811,57
900	62**00900	6842,49	6177,49	6595,16	8880,93

(**)^o

CARRETE NERVADO		
DN	CODIGO	P.V.P.
80x800	620508080	121,07
100x800	620510080	149,18
125x800	620512080	212,41
150x800	620515080	245,89
200x800	620520080	339,96
250x800	620525080	499,30
300x1000	620530100	711,91
350x1000	620535100	931,17
400x1000	620540100	1133,41
450x1000	620545100	1399,96
500x1000	620550100	1743,56
600x1000	620560100	2616,23
800x1000	620580100	5670,71





ACCESORIO DE FUNDICION CON BRIDA PARA TUBERIA DE FUNDICION

REDUCCION						
DN	CODIGO	P.V.P.		DN	CODIGO	P.V.P.
65/40	620200604	53,57		300/150	620203015	389,63
65/50	620200605	63,18		300/200	620203020	391,69
80/40	620200804	48,34		300/250	620203025	408,40
80/50	620200805	49,61		350/200	620203520	434,94
80/65	620200806	53,25		350/250	620203525	487,97
100/40	620201004	67,22		350/300	620203530	570,25
100/50	620201005	53,25		400/150	620204015	531,44
100/65	620201006	54,55		400/200	620204020	539,22
100/80	620201008	57,11		400/250	620204025	542,67
125/40	620201204	79,10		400/300	620204030	585,33
125/50	620201205	76,10		400/350	620204035	658,81
125/65	620201206	71,34		450/300	620204530	948,84
125/80	620201208	74,67		450/400	620204540	1002,42
125/100	620201210	73,42		500/200	620205020	850,48
150/40	620201504	87,01		500/250	620205025	881,13
150/50	620201505	92,94		500/300	620205030	891,74
150/65	620201506	94,84		500/350	620205035	908,58
150/80	620201508	73,42		500/400	620205040	960,67
150/100	620201510	75,46		500/450	620205045	982,89
150/125	620201512	79,81		600/300	620206030	1194,64
200/80	620202008	108,61		600/350	620206035	1243,67
200/100	620202010	111,02		600/400	620206040	1270,77
200/125	620202012	118,65		600/500	620206050	1474,49
200/150	620202015	129,00		700/500	620207050	2690,51
250/100	620202510	198,31		800/400	620208040	3529,33
250/125	620202512	200,25		800/500	620208050	3561,04
250/150	620202515	206,23		800/600	620208060	3632,44
250/200	620202520	224,06		800/700	620208070	3664,16
300/100	620203010	348,65		900/500	620209050	3934,03

CRUZ			
	DN	CODIGO	P.V.P.
	80x80	620400808	113,70
	100x100	620401010	153,46
	125x125	620401212	172,13
	150x150	620401515	233,22
	200x200	620402020	420,35
	250x250	620402525	577,33
	300x300	620403030	800,39
400x400	620404040	2064,06	



ACCESORIO DE FUNDICION CON BRIDA PARA TUBERIA DE FUNDICION

TE						
DN	CODIGO	P.V.P.		DN	CODIGO	P.V.P.
40/40	620100404	64,58		250/250	620102525	615,35
50/50	620100505	93,04		300/80	620103008	696,52
65/40	620100604	93,27		300/100	620103010	707,35
65/50	620100605	93,27		300/150	620103015	711,48
65/65	620100606	94,73		300/200	620103020	740,40
80/40	620100804	100,64		300/250	620103025	817,23
80/50	620100805	103,58		300/300	620103030	835,12
80/65	620100806	100,95		350/80	620103508	1055,84
80/80	620100808	93,81		350/100	620103510	1094,72
100/40	620101004	107,45		350/150	620103515	1137,03
100/50	620101005	118,16		350/200	620103520	1174,96
100/65	620101006	119,52		350/250	620103525	1206,90
100/80	620101008	111,28		350/300	620103530	1252,41
100/100	620101010	115,10		350/350	620103535	1262,10
125/40	620101204	145,72		400/80	620104008	1253,94
125/50	620101205	146,51		400/100	620104010	1302,52
125/65	620101206	147,28		400/150	620104015	1325,41
125/80	620101208	136,21		400/200	620104020	1357,24
125/100	620101210	142,35		400/250	620104025	1393,83
125/125	620101212	141,99		400/300	620104030	1439,26
150/40	620101504	183,97		400/350	620104035	1503,04
150/50	620101505	184,28		400/400	620104040	1553,16
150/65	620101506	184,28		450/80	620104508	1584,73
150/80	620101508	171,63		450/100	620104510	1648,48
150/100	620101510	174,75		450/150	620104515	1680,37
150/125	620101512	215,99		450/200	620104520	1598,96
150/150	620101515	193,92		450/250	620104525	1633,00
200/40	620102004	253,37		450/300	620104530	1667,05
200/50	620102005	254,08		450/350	620104535	1730,88
200/65	620102006	253,48		450/400	620104540	1787,85
200/80	620102008	247,15		450/450	620104545	1838,91
200/100	620102010	250,13		500/80	620105008	1768,79
200/125	620102012	263,73		500/100	620105010	1801,12
200/150	620102015	313,64		500/150	620105015	1832,25
200/200	620102020	337,61		500/200	620105020	1868,83
250/65	620102506	506,29		500/250	620105025	1894,72
250/80	620102508	525,41		500/300	620105030	1938,13
250/100	620102510	522,21		500/400	620105040	2034,94
250/150	620102515	587,61		500/450	620105045	2117,29
250/200	620102520	594,21		500/500	620105050	2208,89





ACCESORIO DE FUNDICION CON BRIDA PARA TUBERIA DE FUNDICION

CARRETE						
DN	CODIGO	P.V.P.		DN	CODIGO	P.V.P.
40/80	620304008	21,15		125/250	620312025	114,65
40/100	620304010	21,31		125/500	620312050	134,85
40/150	620304015	25,91		125/1000	620312100	197,77
40/200	620304020	28,00		150/100	620315010	83,66
40/250	620304025	33,86		150/150	620315015	90,71
40/300	620304030	39,39		150/200	620315020	99,95
40/400	620304040	43,86		150/250	620315025	101,83
40/500	620304050	79,20		150/300	620315030	118,93
50/500	620305050	68,70		150/400	620315040	134,81
50/600	620305060	73,80		150/500	620315050	139,89
50/1000	620305100	90,30		150/800	620315080	251,12
65/250	620306025	55,63		150/1000	620315100	264,84
65/500	620306050	77,79		200/100	620320010	167,28
80/100	620308010	56,27		200/200	620320020	173,96
80/150	620308015	56,27		200/250	620320025	176,98
80/200	620308020	56,94		200/300	620320030	218,49
80/250	620308025	57,83		200/400	620320040	226,48
80/300	620308030	62,27		200/500	620320050	235,91
80/400	620308040	71,03		200/1000	620320100	436,51
80/500	620308050	78,48		250/250	620325025	225,71
80/600	620308060	110,30		250/500	620325050	338,03
80/800	620308080	132,21		250/1000	620325100	518,27
80/1000	620308100	156,75		300/250	620330025	397,55
100/100	620310010	65,55		300/500	620330050	435,13
100/150	620310015	65,60		300/1000	620330100	640,20
100/200	620310020	69,51				
100/250	620310025	72,57				
100/300	620310030	80,47				
100/400	620310040	90,40				
100/500	620310050	100,00				
100/600	620310060	153,08				
100/800	620310080	160,16				
100/1000	620310100	215,72				

ACCESORIO DE FUNDICION BRIDA-ENCHUFE PARA TUBERIA DE FUNDICION

BRIDA ENCHUFE

DN	CODIGO	P.V.P.
65	610200065	54,26
80	610200080	68,51
100	610200100	76,51
125	610200125	96,75
150	610200150	113,06
200	610200200	155,49
250	610200250	236,33
300	610200300	319,76
350	610200350	388,28
400	610200400	454,46
450	610200450	635,12
500	610200500	900,86
600	610200600	1275,28
700	610200700	2446,73
800	610200800	3140,70
900	610200900	3943,27



BRIDA ESPIGA

DN	CODIGO	P.V.P.
65	610400065	37,34
80	610400080	45,17
100	610400100	56,61
125	610400125	75,27
150	610400150	97,81
200	610400200	135,52
250	610400250	192,73
300	610400300	252,96
350	610400350	333,68
400	610400400	424,68
450	610400450	521,77
500	610400500	758,37
600	610400600	964,64
700	610400700	2637,08
800	610400800	3204,16
900	610400900	3435,11





ACCESORIO DE FUNDICION BRIDA-ENCHUFE PARA TUBERIA DE FUNDICION

TE						
DN	CODIGO	P.V.P.		DN	CODIGO	P.V.P.
65/65	610100606	83,36		400/150	610104015	991,89
80/40	610100804	100,88		400/200	610104020	1127,90
80/50	610100805	105,19		400/250	610104025	1224,42
80/65	610100806	105,65		400/300	610104030	1319,34
80/80	610100808	114,15		400/350	610104035	1439,00
100/40	610101004	113,62		400/400	610104040	1431,01
100/65	610101006	118,39		450/80	610104508	1076,85
100/80	610101008	127,42		450/100	610104510	1076,85
100/100	610101010	134,85		450/150	610104515	1228,40
125/40	610101204	151,11		450/200	610104520	1252,33
125/65	610101206	151,09		450/250	610104525	1499,61
125/80	610101208	151,11		450/300	610104530	1555,44
125/100	610101210	151,11		450/350	610104535	1635,21
125/125	610101212	168,84		450/400	610104540	1714,98
150/40	610101504	173,04		450/450	610104545	1938,32
150/65	610101506	173,02		500/80	610105008	1600,46
150/80	610101508	195,04		500/100	610105010	1600,48
150/100	610101510	210,38		500/150	610105015	1600,48
150/125	610101512	219,05		500/200	610105020	1600,48
150/150	610101515	230,06		500/250	610105025	1612,44
200/65	610102006	229,96		500/300	610105030	1802,72
200/80	610102008	260,32		500/350	610105035	1902,44
200/100	610102010	272,75		500/400	610105040	2002,13
200/150	610102015	313,01		500/450	610105045	2186,24
200/200	610102020	334,99		500/500	610105050	2337,16
250/80	610102508	387,66		600/80	610106008	2232,23
250/100	610102510	387,66		600/100	610106010	2232,23
250/150	610102515	387,66		600/150	610106015	2232,23
250/200	610102520	420,50		600/200	610106020	2232,23
250/250	610102525	473,59		600/250	610106025	2232,23
300/80	610103008	667,98		600/300	610106030	2400,98
300/100	610103010	667,98		600/350	610106035	2484,73
300/150	610103515	667,98		600/400	610106040	2568,49
300/200	610103020	667,98		600/450	610106045	2967,31
300/250	610103025	667,98		600/500	610106050	3294,35
300/300	610103030	667,98		600/600	610106060	3390,08
350/80	610103508	781,28		700/150	610107015	3858,57
350/100	610103510	781,28		700/200	610107020	3890,19
350/150	610103515	781,28		800/200	610108020	4651,59
350/200	610103520	857,09		800/300	610108030	5099,69
350/250	610103525	940,84		800/400	610108040	5603,31
350/300	610103530	1012,26		800/500	610108050	6955,54
350/350	610103535	1094,40		800/600	610108060	7927,11
400/80	610104008	913,95		900/200	610109020	4867,11
400/100	610104010	913,95		900/400	610109040	5911,87





ACCESORIO DE FUNDICION ENCHUFE PARA TUBERIA DE FUNDICION

		CODIGO			
DN	CODIGO	11°	22°	45°	90°
60	60**00060	76,52	76,51	76,51	81,59
80	60**00080	97,24	97,24	97,24	104,51
100	60**00100	113,90	113,91	113,91	118,82
125	60**00125	146,73	146,74	146,74	149,68
150	60**00150	170,83	170,82	170,82	183,23
200	60**00200	238,63	238,63	238,63	269,33
250	60**00250	393,97	393,97	393,97	490,75
300	60**00300	578,19	578,19	578,19	664,16
350	60**00350	776,57	776,57	776,57	872,77
400	60**00400	794,22	794,22	794,22	1254,81
450	60**00450	970,70	970,71	970,71	1652,84
500	60**00500	1043,78	1169,29	1389,88	1759,98
600	60**00600	1428,81	1610,49	1963,48	2549,29
700	60**00700	3680,02	3910,03	4469,16	6750,53
800	60**00800	4730,88	5222,62	6158,47	7192,02
900	60**00900	5517,75	6278,87	8070,32	11610,77



(**)^o

MANGUITO			TE		
DN	CODIGO	P.V.P.	DN	CODIGO	P.V.P.
60	600300060	83,79	80/80	600100808	154,79
80	600300080	105,78	100/80	600101008	180,24
100	600300100	120,11	100/100	600101010	186,11
125	600300125	148,43	125/125	600101212	255,86
150	600300150	177,14	150/80	600101508	257,06
200	600300200	241,34	150/100	600101510	257,06
250	600300250	319,22	150/150	600101515	276,07
300	600300300	398,21	200/80	600102008	334,22
350	600300350	477,33	200/100	600102010	334,22
400	600300400	612,37	200/150	600102015	349,81
450	600300450	777,67	200/200	600102020	361,16
500	600300500	925,15			
600	600300600	1155,11			
700	600300700	2934,51			
800	600300800	3660,20			
900	600300900	4984,51			





ACCESORIO DE FUNDICION ENCHUFE PARA TUBERIA DE FUNDICION

REDUCCION		
DN	CODIGO	P.V.P.
80/60	600200806	102,50
100/60	600201006	121,30
100/80	600201008	129,52
125/60	600201206	148,29
125/80	600201208	150,11
125/100	600201210	153,80
150/60	600201506	169,64
150/80	600201508	177,81
150/100	600201510	181,23
150/125	600201512	189,45
200/80	600202008	230,66
200/100	600202010	230,66
200/125	600202012	240,35
200/150	600202015	246,20
250/125	600202512	292,86
250/150	600202515	305,85
250/200	600202520	307,09
300/150	600203015	426,17
300/200	600203020	435,44
300/250	600203025	444,80
350/200	600203520	581,85
350/250	600203525	669,85
350/300	600203530	694,95
400/250	600204025	768,78
400/300	600204030	815,05
400/350	600204035	831,46
450/300	600204530	930,10
450/350	600204535	994,52
450/400	600204540	995,45
500/350	600205035	1449,81
500/400	600205040	1461,17
500/450	600205045	1479,41
600/400	600206040	1884,63
600/450	600206045	2100,78
600/500	600206050	2162,28
700/500	600207050	3377,09
800/700	600208070	3991,39





ACCESORIO DE FUNDICION PARA TUBERIA DE PVC



DN	CODIGO	CODO			
		11°	22°	45°	90°
63	71**00063	19,77	19,77	20,93	23,26
75	71**00075	31,64	31,64	33,68	37,77
90	71**00090	44,78	44,78	47,40	52,62
110	71**00110	54,54	54,54	59,78	70,27
125	71**00125	79,28	79,28	82,76	90,33
140	71**00140	87,60	87,60	91,65	99,23
160	71**00160	115,21	115,21	118,70	125,70
200	71**00200	145,73	145,73	154,48	171,95
225	71**00225	221,26	220,92	227,09	258,86
250	71**00250	246,34	246,48	262,33	292,95
315	71**00315	338,97	342,65	365,96	418,40
400	71**00400	831,05	833,85	865,70	1084,32

(**)^o

TE 3 ENCHUFES

DN	CODIGO	P.V.P.	DN	CODIGO	P.V.P.
63-63	710200606	28,04	200-75	710202007	170,70
75-63	710200706	32,19	200-90	710202009	170,70
75-75	710200707	38,57	200-110	710202010	174,75
90-63	710200906	43,05	200-125	710202012	206,30
90-75	710200907	46,45	200-140	710202014	206,30
90-90	710200909	56,21	200-160	710202016	210,43
110-63	710201006	54,31	200-200	710202020	231,13
110-75	710201007	56,69	225-110	710202210	236,08
110-90	710201009	63,95	225-160	710202216	266,27
110-110	710201010	78,31	225-225	710202222	279,99
125-63	710201206	75,87	250-90	710202509	234,63
125-75	710201207	77,91	250-110	710202510	242,91
125-90	710201209	79,04	250-125	710202512	255,88
125-110	710201210	89,95	250-140	710202514	258,29
125-125	710201212	104,60	250-160	710202516	277,12
140-110	710201410	112,88	250-200	710202520	316,09
140-125	710201412	140,12	250-250	710202525	343,31
140-140	710201414	140,12	315-110	710203010	334,16
160-75	710201607	111,67	315-140	710203014	341,00
160-90	710201609	118,05	315-160	710203016	404,38
160-110	710201610	126,88	315-200	710203020	464,92
160-125	710201612	161,31	315-250	710203025	492,41
160-140	710201614	167,86	315-315	710203030	499,40
160-160	710201616	167,86			





ACCESORIO DE FUNDICION PARA TUBERIA DE PVC

BRIDA ENCHUFE			BRIDA ESPIGA		
DN	CODIGO	P.V.P.	DN	CODIGO	P.V.P.
63	710300063	28,51	63	710500063	28,52
75	710300075	29,94	75	710500075	27,07
90	710300090	37,98	90	710500090	32,05
110	710300110	51,14	110	710500110	40,21
125	710300125	62,65	125	710500125	55,94
140	710300140	78,17	140	710500140	63,50
160	710300160	86,45	160	710500160	70,50
200	710300200	136,09	200	710500200	101,97
225	710300225	155,77	225	710500225	110,78
250	710300250	181,68	250	710500250	120,60
315	710300315	249,98	315	710500315	238,58
400	710300400	757,27			
500	710300500	1190,85			



REDUCCION					
DN	CODIGO	P.V.P.	DN	CODIGO	P.V.P.
075-063	713075063	20,32	200-110	713200110	106,83
090-063	713090063	27,53	200-125	713200125	121,25
090-075	713090075	28,31	200-140	713200140	126,68
110-063	713110063	31,41	200-160	713200160	129,89
110-075	713110075	37,40	225-110	713225110	191,13
110-090	713110090	47,30	225-160	713225160	201,45
125-063	713125063	48,90	225-200	713225200	210,11
125-075	713125075	49,94	250-140	713250140	208,43
125-090	713125090	49,93	250-160	713250160	222,43
125-110	713125110	67,42	250-200	713250200	241,20
140-090	713140090	59,04	315-090	713315090	266,13
140-110	713140110	67,48	315-110	713315110	277,61
140-125	713140125	77,31	315-125	713315125	290,15
160-075	713160075	74,30	315-140	713315140	317,93
160-090	713160090	77,06	315-160	713315160	341,39
160-110	713160110	80,51	315-200	713315200	359,27
160-125	713160125	83,54	315-250	713315250	387,72
160-140	713160140	87,11	400-250	713400250	540,89
200-090	713200090	119,48	400-315	713400315	613,02





ACCESORIO DE FUNDICION PARA TUBERIA DE PVC

TE DOBLE ENCHUFE / BRIDA

DN	CODIGO	P.V.P.		DN	CODIGO	P.V.P.
63/50	710100605	38,41		200/100	710102010	201,68
63/65	710100606	40,75		200/125	710102012	216,14
75/50	710100705	48,83		200/150	710102015	229,62
75/65	710100706	50,00		200/200	710102020	242,45
90/50	710100905	59,58		225/80	710102208	212,91
90/65	710100906	61,95		225/100	710102210	212,91
90/80	710100908	79,44		225/150	710102215	265,76
110/50	710101105	73,18		225/200	710102220	285,75
110/65	710101106	73,18		250/50	710102505	299,38
110/80	710101108	88,92		250/65	710102506	299,38
110/100	710101110	91,83		250/80	710102508	299,38
125/50	710101205	79,71		250/100	710102510	299,38
125/65	710101206	88,59		250/125	710102512	322,11
125/80	710101208	97,32		250/150	710102515	322,11
125/100	710101210	103,16		250/200	710102520	339,57
125/125	710101212	106,64		250/250	710102525	380,20
140/50	710101405	102,74		315/65	710103006	378,56
140/65	710101406	102,74		315/80	710103008	378,56
140/80	710101408	110,33		315/100	710103010	386,36
140/100	710101410	145,85		315/150	710103015	465,00
140/125	710101412	152,26		315/200	710103020	491,22
160/50	710101605	141,45		315/250	710103025	515,97
160/65	710101606	141,45		315/300	710103030	525,08
160/80	710101608	144,92		400/80	710104008	841,01
160/100	710101610	157,75		400/100	710104010	1107,53
160/125	710101612	166,46		400/150	710104015	1169,31
160/150	710101615	175,21		400/200	710104020	1253,64
200/50	710102005	198,18		400/300	710104030	1662,05
200/65	710102006	198,18		400/400	710104040	2012,93
200/80	710102008	198,18				

TAPON HEMBRA

DN	CODIGO	P.V.P.
63	710000063	12,20
75	710000075	17,14
90	710000090	24,57
110	710000110	33,68
125	710000125	42,83
140	710000140	49,04
160	710000160	65,46
200	710000200	85,98
225	710000225	108,42
250	710000250	126,09
315	710000315	197,55





UNION ARPOL

UNION ARPOL

DN	CODIGO	P.V.P.	TIPO
ANCHO 75MM			
60-64	260000060	181,51	IBXR-A2E40
ANCHO 90MM			
74-78	260000074	190,85	IBXR-A2E30
80-86	260000080	193,43	IBXR-A2E30
87-93	260000087	195,42	IBXR-A2E30
98-106	260000098	201,42	IBXR-A2E30
107-111	260000107	202,80	IBXR-A2E30
110-116	260000110	207,94	IBXR-A2E30
118-125	260000118	211,92	IBXR-A2E30
125-131	260000125	211,92	IBXR-A2E20
131-136	260000131	214,55	IBXR-A2E20
137-144	260000137	216,84	IBXR-A2E20
147-156	260000147	222,82	IBXR-A2E20
156-162	260000156	224,53	IBXR-A2E20



DN	CODIGO	P.V.P.	TIPO	DN	CODIGO	P.V.P.	TIPO
ANCHO 140MM				ANCHO 140MM			
156-168	260100156	327,77	IBYR-A2E23	403-415	260100403	595,68	ICYR-A2E13
166-178	260100166	327,77	IBYR-A2E23	410-422	260100410	595,68	ICYR-A2E13
173-185	260100173	327,77	IBYR-A2E23	419-431	260100419	595,68	ICYR-A2E13
186-198	260100186	327,77	IBYR-A2E23	425-437	260100425	595,68	ICYR-A2E13
194-206	260100194	327,77	IBYR-A2E23	433-445	260100433	595,68	ICYR-A2E13
202-214	260100202	355,86	IBYR-A2E18	450-462	260100450	629,55	ICYR-A2E11
217-229	260100217	355,86	IBYR-A2E18	467-479	260100467	629,55	ICYR-A2E11
231-243	260100231	355,86	IBYR-A2E18	477-489	260100477	629,55	ICYR-A2E11
248-260	260100248	355,86	IBYR-A2E18	487-499	260100487	629,55	ICYR-A2E11
271-283	260100271	383,98	IBYR-A2E15	493-505	260100493	629,55	ICYR-A2E11
279-291	260100279	383,98	IBYR-A2E15	504-520	260100504	718,80	IDYR-A2E13
292-304	260100292	383,98	IBYR-A2E15	525-541	260100525	718,80	IDYR-A2E13
310-322	260100310	412,04	IBYR-A2E12	539-555	260100539	718,80	IDYR-A2E13
320-332	260100320	412,04	IBYR-A2E12	557-573	260100557	756,23	IDYR-A2E12
329-341	260100329	412,04	IBYR-A2E12	567-583	260100567	756,23	IDYR-A2E12
338-350	260100338	412,04	IBYR-A2E12	583-599	260100583	756,23	IDYR-A2E12
349-361	260100349	412,04	IBYR-A2E12	599-615	260100599	756,23	IDYR-A2E12
359-371	260100359	440,08	IBYR-A2E11	614-630	260100614	1060,83	IEYR-A2E13
372-384	260100372	440,08	IBYR-A2E11	630-646	260100630	1060,83	IEYR-A2E13
379-391	260100379	440,08	IBYR-A2E11	650-666	260100650	803,23	ICYR-A2E8
394-406	260100394	440,08	IBYR-A2E11	676-692	260100676	803,23	ICYR-A2E8



UNION ARPOL

UNION ARPOL							
DN	CODIGO	P.V.P.	TIPO	DN	CODIGO	P.V.P.	TIPO
ANCHO 200MM				FIX-U (Silicona Azul)			
166-178	260200166	449,75	IBZR-A2E23	63	260400063S	244,62	A2SA16
173-185	260200173	449,75	IBZR-A2E23	75	260400075S	272,93	A2SA16
186-198	260200186	449,75	IBZR-A2E23	90	260400090S	293,70	A2SA16
194-206	260200194	449,75	IBZR-A2E23	110	260400110S	320,88	A2SA16
202-214	260200202	483,15	IBZR-A2E18	125	260400125S	371,19	A2SA16
210-222	260200210	483,15	IBZR-A2E18	140	260400140S	436,60	A2SA16
217-229	260200217	483,15	IBZR-A2E18	160	260400160S	467,95	A2SA16
231-243	260200231	483,15	IBZR-A2E18	180	260400180S	832,75	A2SA16
242-254	260200242	483,15	IBZR-A2E18	200	260400200S	899,82	A2SA16
248-260	260200248	483,15	IBZR-A2E18	225	260400225S	956,67	A2SA16
271-283	260200271	516,63	IBZR-A2E15	250	260400250S	1015,77	A2SA16
279-291	260200279	516,63	IBZR-A2E15	315	260400315S	1219,73	A2SA16
292-304	260200292	516,63	IBZR-A2E15	355	260400355S	1467,06	A2SA16
310-322	260200310	550,06	IBZR-A2E12	400	260400400S	1582,21	A2SA16
320-332	260200320	550,06	IBZR-A2E12				
329-341	260200329	550,06	IBZR-A2E12				
338-350	260200338	550,06	IBZR-A2E12				
349-361	260200349	550,06	IBZR-A2E12				
359-371	260200359	583,54	IBZR-A2E11				
372-384	260200372	583,54	IBZR-A2E11				
379-391	260200379	583,54	IBZR-A2E11				
394-406	260200394	583,54	IBZR-A2E11				
403-415	260200403	792,17	ICZR-A2E13				
410-422	260200410	792,17	ICZR-A2E13				
419-431	260200419	792,17	ICZR-A2E13				
425-437	260200425	792,17	ICZR-A2E13				
433-445	260200433	792,17	ICZR-A2E13				
450-462	260200450	886,04	IDZR-A2E14				
467-479	260200467	886,04	IDZR-A2E14				
477-489	260200477	886,04	IDZR-A2E14				
487-499	260200487	886,04	IDZR-A2E14				
493-505	260200493	886,04	IDZR-A2E14				
504-520	260200504	976,75	IDZR-A2E13				
525-541	260200525	976,75	IDZR-A2E13				
539-555	260200539	976,75	IDZR-A2E13				
548-564	260200548	976,75	IDZR-A2E13				
557-573	260200557	1023,17	IDZR-A2E12				
567-583	260200567	1023,17	IDZR-A2E12				
583-599	260200583	1023,17	IDZR-A2E12				
599-615	260200599	1023,17	IDZR-A2E12				
614-630	260200614	1069,57	IDZR-A2E11				
630-646	260200630	1069,57	IDZR-A2E11				
650-666	260200650	1116,02	IDZR-A2E10				
676-692	260200676	1116,02	IDZR-A2E10				

